



JINZEN®



CONTENTS

目錄

金振旋梭 JINZEN HOOKS	P032	重机 JUKI 1900/1903	P190
金振梭壳 JINZEN BOBBIN CASES	P039	重机 JUKI 781	P192
金振摆梭 JINZEN SHUTTLE HOOKS	P044	重机 JUKI 373	P195
金振梭心 JINZEN BOBBINS	P047	重机 JUKI DDL9000	P198
		重机 JUKI 380	P200
金振刀具 JINZEN KNIFES	P048	重机 JUKI 1190	P202
金振针板 JINZEN NEEDLE PLATES	P063	于仁 UNION SPECIAL 35800	P204
金振针位 JINZEN GAUGE SET	P072	重机 JUKI 2280	P206
金振送布牙 JINZEN FEED DOG	P126	重机 JUKI 271/391	P209
金振弯针 JINZEN LOOPERS	P130	重机 JUKI MO2516	P210
金振针夹 JINZEN NEEDLE CLAMP	P138	重机 JUKI MO3600	P212
金振压脚 JINZEN PRESSER FOOT	P141	重机 JUKI MO3300	P214
		重机 JUKI 8700	P216
夹线器组件 THREAD TENSION ASM	P152	重机 JUKI 522	P218
打褶器, 定规 ATTACHMENT & GAUGE	P156	重机 JUKI 3168	P219
金振卷边筒 JINZEN FOLDER	P160	重机 JUKI 515	P220
套结机拖板, 压脚 FEED PLATE & WORK CLAMP	P178	重机 JUKI 1162	P221
各类针杆 NEEDLE BAR	P185	重机 JUKI 1790	P222
重机 JUKI 1850	P188	兄弟 BROTHER 101/735	P224

兄弟 BROTHER7200	P226	罗拉车 9901	P290
兄弟 BROTHER 430	P228	标准TYPICAL341	P291
兄弟 BROTHER 430D	P230	标准TYPICAL0302/0318	P292
兄弟 BROTHER 814	P232	精工8B/胜家SINGER591	P294
兄弟 BROTHER 845	P235	削皮机 801	P295
兄弟 BROTHER 917	P236	伊士曼 EASTMAN	P296
兄弟 BROTHER 927/928	P238	电裁剪 KM	P298
兄弟 BROTHER 981	P240	断布机零件	P300
兄弟 BROTHER 531/551	P244	园刀/电剪 RS-100/RS-90	P301
兄弟 BROTHER N31/HE800A	P245	绣花机 EMBROIDER	P302
飞马 PEGASUS M800	P247	胶订机 ST9000	P307
飞马 PEGASUS M600	P248	家用机 JA1-1/JA2-2	P308
飞马 PEGASUS M700	P250	多功能 307	P310
飞马 PEGASUS W500	P252	胜家SINGER974	P312
飞马 PEGASUS W664	P254	兄弟多功能 BROTHER 5500	P314
飞马 PEGASUS EX3200	P256	真善美 JANOME 2049	P316
银箭 SIRUBR VC008	P259	家用多功能压脚 <small>Sawing Machine Feet & Accessory For Household</small>	P318
银箭 SIRUBR F007/C007	P260	暗缝机/大白扣	P324
银箭 SIRUBR 747/757	P262		
银箭 SIRUBR 988	P264	金板喷枪,配件 JINZEN GUN & PARTS	P326
宝狮 KINGTEX SH7000	P266	熨斗,配件,熨斗靴IRON & SHOES	P328
关西 KASAI SPECIAL 1404	P268	喷漆 PAINT FOR MACHINE	P342
关西 KASAI 1508	P270	标枪,胶针 TAGGIN GUN & NEEDLE PIN	P343
关西 KASAI 33N	P271	剪刀 SCISSORS	P346
大和 YAMATO AZ8500	P273	工作灯 MACHINE LIGHT	P352
大和 YAMATO 1500	P274	工具附件 TOOLS & ATTACHMENT	P356
大和 YAMATO 2500	P276	皮带罩 BELT COVER	P370
星菱 SHING LING 777	P278	门板组件 FRONT COVER ASM	P372
星菱 SHING LING SL700	P280	护眼组件 EYE COVER	P374
杜克普 DURKOPP 558	P282	挑线杆,油盘,线架 THREAD STAND	P376
胜家 SINGER 20U	P284	电裁剪 CUNTTING MACHINE	P384
牛郎 NEWLONG NP-7	P286	拖轮系列 PULLER ATTACHMENT	P388
百福 PFAFF 335	P287	成衣剪线机 THREAD TRIMMER	P394
高头车 810/820	P288	台湾拖轮:PULLERATTACHMENT	P406

温馨提示:

画册的编号解释: JZ代表JINZEN的第一个拼音字母, 数字代表序号, 金板样本中的序号从10001 10002 10003 依次从小到大的顺序排列, 考虑到以后会有增加新的配件或机型, 所以在不同的种类或机型后留有空号码, 由此带来的不便敬请谅解。

Warm tips:

Number explanation for this Catalogue: JZ stand for the first phonetic alphabet of JINZEN, Figure stand for the serial number. The serial number of 10001, 10002, 10003 in the JINZEN catalogue turn from small to large order, taking into account that we will have to add new accessories or models, so we remain empty after the number for different types and models, so please understand the inconvenience as the result.

JINZEN®

旋梭技术检测标准

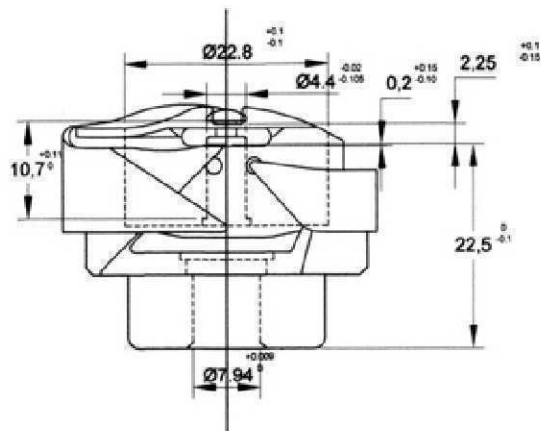

金振旋梭技术检测标准

1. 旋梭壳于旋梭架的轴向间隙为0.02-0.05mm
2. 旋梭壳于旋梭架的径向间隙为0.02-0.06mm
3. 旋梭壳 $\varnothing 7.94$ mm孔端面至勾线头平面距离 $22.5 -0.10$ mm
4. 勾线头平面到定位槽底面的距离 $2.25 +0.15$ mm
5. 旋梭壳孔径 $7.94 +0.009$ mm
6. 旋梭架轴芯直径 $4.4 -0.02$ mm
7. 旋梭架内圆孔径 $22.8 -0.1$ mm
8. 旋梭架芯轴底平面到芯子槽上平面距离 $10.7 +0.11$ mm
9. 旋梭架针槽下平面应低于旋梭壳勾线头平面 $0.2 +0.15$ mm
10. 旋梭过线部位应光滑无锐棱其粗糙度Ra不大于0.2 μ m
11. 旋梭的梭壳、梭架热处理硬度表面HV600
12. 导线板螺钉边缘应低于导线板，螺钉起子槽不应有损伤，旋梭不应有伤痕、裂痕、毛刺、锈斑等缺陷
13. 梭架表面镀铬，层深不低于0.006mm，且不允许起泡、脱壳、毛刺现象
14. 旋梭壳与旋梭架配合良好，转动灵活，无异常声响，当转速为5400转/min时，其噪声级不大于78dB(A)

JINZEN TECHNICAL TESTING STANDARD OF HOOK

1. The space of axial direction between bobbin case body and hook body is 0.02- 0.05mm
2. The space of radial direction between bobbin case body and hook body is 0.02-0.06mm
3. $\varnothing 7.94$ mm bobbin case, the distance from the side with hole to the thread hooking head is $22.5 -0.10$ mm
4. The space from the thread hooking head to the bottom of locating slot is $2.25 +0.15$ mm
5. The dore diameter of bobbin case is $7.94 +0.009$ mm
6. Th diameter of central spindle of hook body is $4.4 -0.02$ mm
7. The dore diameter of hook body is $22.8 -0.1$ mm
8. The distance from the central spindle of hook body to the plane of core groove is $10.7 +0.11$ mm
9. The plane of needle groove of hook body should be lower $0.2 +0.15$ mm than the plane of thread hooking head of bobbin case body.
10. The part of hook thread guide must be smooth, and Ra should be less than 0.2 μ m
11. The hardness of bobbin case and hook body reached to HV600 through heat treatment.
12. The screw's edge of wiring board should be lower than wiring board, the groove of screw driver have to keep smooth, and the hook must avoid these defects, such as scratch, crack, burr, rust.
13. There have plated chrome on the hook body, the depth is more than 0.006mm, and have to avoid blistering, unshell, burr.
14. Bobbin case and hook body have a good match, flexible rotation, no abnormal sound, and the sound level less than 78dB(A) under the rotational speed of 5400 revolutions per minute.

	JZ-10001 DB1-Z16 KR24 7.24mm		JZ-10002 HSH-7.94A(MTQ) KHS12-RY 7.94mm
For: BROTHER LE2-B861-1, JUKI LZ-27.29.40.271.403 MEIJIA G15-2 ADLER 199.289.489 CONSEW 133A.825 SUNSTAR KLZ-371 UNICORN LZ2-H272 (needle slot:16mm)	For: TAJIMA TME.TMEF.TMLE ETC BUTTERFLY GY4-1 TYPICAL GYD20-6 YINGLUN GY101-1 SUNSTAR SWF/A-WE1218-T1201 (small hook)		
	JZ-10003 DB1-Z16B KR24-B 7.24mm		JZ-10004 HSH-7.94A(M1QTS) KHS12-RYNW 7.94mm
For: BROTHER TZ1-B651.B652 BAS-400.LE2-B861-7 I-SIAN IS-335 KING'S HC-335 MILLION SPECIAL MS-335 TAKING TK-652 YULUN YLM-335 (needle slot:16mm)	For: BARUDAN BEMR.BEMS.BEMX (small hook.teflon base)		
	JZ-10005 DB1-Z(20) KR24-U 7.24mm		JZ-10006 HSH-7.94ATR(MTQ) KHS12-RYP 7.94mm
For: SINGER 20U.20U13.23 KERDER KD-20U PANDA(JIANN LIAN) JU-20U SIROKUMA LM-600 (needle slot:18mm)	For: TAJIMA TMBE.TME.TME-D TMFD-C.TMFX-C TMLE.TMLG. (Small hook) (under trimming machine)		
	JZ-10007 HSH-7.94A KHS12-R 7.94mm		JZ-10008 HSH-7.94ATR(MTQTS) KHS12-RYPN 7.94mm
For: BROTHER DB2-B706-5.B714-5.B755-5 JANOME DB-J705.706 MITSUBISHI DB-130-12.13.130G-12. 130G-127.DY-340-12 SINGER 391U.400W.402W.451K. NITAKA TC-1553.1555 NAKAJIMA DSN178-3	For: TAJIMA TMBE.TME.TME-D TMFD-C.TMFX-C TMLE.TMLG. (Small hook.teflon base) (under trimming machine)		
	JZ-10009 HSH-7.94B KHS12-S 7.94mm		JZ-10010 HPF-134/ZSK 7.24mm
For: BROTHER DB2-B714-3.B753.B795-013 JUKI DDL-127.227.541.555.5550 MITSUBISHI DB-126-10.130G-10.171 LS2-1130-M.MOB-150-MOB SINGER 281-81.83.366.400W 600W TOYOTA AD148.156.345.352.D146.347.352 JANOME DB-J701-4.J707-8 (gold base)	For: TAJIMA TMBE.TME.TME-D TMFD-C.TMFX-C TMLE.TMLG. (Large hook.teflon base)		
	JZ-10011 HSH-7.94B KHS12-S 7.94mm		JZ-10012 HSM-A(MQTS) KHS20-RYN 7.94mm
For: BROTHER DB2-B714-3.B753.B795-013 JUKI DDL-127.227.541.555.5550 MITSUBISHI DB-126-10.130G-10.171 LS2-1130-M.MOB-150-MOB SINGER 281-81.83.366.400W 600W TOYOTA AD148.156.345.352.D146.347.352 JANOME DB-J701-4.J707-8	For: TAJIMA TMBE.TME.TME-D TMFD-C.TMFX-C TMLE.TMLG. (Large hook.teflon base)		
	JZ-10013 HSH-7.94ATR KHS12-RP 7.94mm		JZ-10014 HSM-ATR(MTQTS) KHS20-RYPN 7.94mm
For: ABLE HB-300 CHUAN NENG CN-991.992	For: TAJIMA TMBE.TME.TME-D TMFD-C.TMFX-C TMLE.TMLG. (Large hook.teflon base) (under trimming machine)		
	JZ-10015 HSH-7.94BTR KHS12-SP 7.94mm		JZ-10016 HSM-B1H KHS20-GTB 7.94mm
For: JANOME DB-J709 JUKI DDL-500.DLD-432-2.DMN-530 TOYOTA AD157-623.-666.AD157A-622 CONSEW 290RATCW.290RTC.290RTCW ABLE HBS-2700 SUNSTAR KM-235A NAKAJIMA 178Y-2	For: BROTHER DB2-B745-5 JUKI DDL-201H MITSUBISHI DY330-22D.337-2S ABLE HB-380		



 <p>JZ-10017</p> <p>For: TYPICAL GC6-9, GC6-10 (extra heavy materials, thick lines)</p> <p>7.94mm</p>	 <p>JZ-10018 HSH-21-40(J) KRT21-J</p> <p>For: JUKI LH-512-.512-3.515</p> <p>8.01mm</p>
 <p>JZ-10019 HSM-A1 KHS20-RTB</p> <p>For: BROTHER DB2-B745-7, B797, B797-5 TAJIMA TMB-E, TMB-W, TMW JUKI DDL-201S (heavy materials)</p> <p>7.94mm</p>	 <p>JZ-10020 HSH-21-40(AJ) KRT21-R</p> <p>For: JUKI LH-512H, 515H (heavy materials) (short gib)</p> <p>8.01mm</p>
 <p>JZ-10021</p> <p>For: TYPICAL GC2603, GC2605</p> <p>7.94mm</p>	 <p>JZ-10022 HSH-31 KRT31-R</p> <p>For: SINGER 21W180, 46W61, 47W62, 63, 52W30, 31, 131W CONSEW 228, 228-11, 228R-1, 11, 229, 229R, 229R-1, 238, 238-1, 282, 282R-1, 289R-1, 358R-1</p> <p>7.93mm</p>
 <p>JZ-10023 HSM-ATR(1Q)</p> <p>For: BROTHER BAS-412, 416, 423</p> <p>7.94mm</p>	 <p>JZ-10024 HSH-31(B) KRT31-11S</p> <p>For: SEIKO CW-1, 7.7B, 8.8B, 8V, 8BV SINGER 47W70, 131W CONSEW 207, 223, 223R, 223R-1, 227, 382, 382R, 388, 388R-1, 389, 389R-1 (full gib)</p> <p>7.93mm</p>
 <p>JZ-10025 HPF-335</p> <p>For: PFAFF 138, 234, 331, 333, 335, 337-734</p> <p>7.24mm</p>	 <p>JZ-10026 HSH-31(6) KRT31-NR</p> <p>For: YAKUMO 981, 982 GOLDEN WHEEL CS-810, 820 NITAKA TC-810S, 820S SUNSTAR KM-867, KPW-827B</p> <p>7.93mm</p>
 <p>JZ-10027 HPF-335(5) KR69-V</p> <p>For: SEIKO LSC-8B, 8BV CONSEW 277R, 277RFS</p> <p>7.24mm</p>	 <p>JZ-10028 HPF-390 KRT390G</p> <p>For: PFAFF 390</p> <p>7.925mm</p>
 <p>JZ-10029 HPF-490 KRT470-S</p> <p>For: PFAFF 471~493 SEIKO PWB-22GW-8W</p> <p>7.92mm</p>	 <p>JZ-10030 HYM-341 KRT341-G</p> <p>For: YAKUMO 341L</p> <p>7.93mm</p>
 <p>JZ-10031 HPF-490(A) KRT470-R</p> <p>For: PFAFF 471~493 SEIKO PWB-8GW (short gib)</p> <p>7.92mm</p>	 <p>JZ-10032 DP2-NJ KRP41-LH</p> <p>For: JUKI LBH-761, 762, 763 DALIAN G13 HUANAN(SOUTH CHINA) G16-1 SHANGGONG G15 SUNGOOD GF11001</p> <p>7.94mm</p>

以客为尊 的服务理念!
THE SERVICE IDEA OF GIVING MANY REGARDS TO CUSTOMS

<p style="text-align: center;">JZ-10033 DP2-NJ771 KRP771</p>  <p>For: JUKI LBH-771-774, 781-784 K-CHANCE KBH-890 TAKING TK-888 DALIAN G18</p> <p style="text-align: right;">7.94mm</p>	<p style="text-align: center;">JZ-10034 HSH-12-15L KRT12-5B</p>  <p>For: BROTHER LT2-831-1, 3B832-1, 3B833 SEIKO LTW-26, 27, 27B, 27BM NITAKA TC2-B842 SUNSTAR KM2-740B</p> <p style="text-align: right;">9.52mm</p>
<p style="text-align: center;">JZ-10035 DP2-LB KRP41-B</p>  <p>For: BROTHER LH4-B814</p> <p style="text-align: right;">7.93mm</p>	<p style="text-align: center;">JZ-10036 HSH-12-15L(H) KRT12-5BHR</p>  <p>For: BROTHER LT2-B831-5, B832-5 (heavy materials)</p> <p style="text-align: right;">9.52mm</p>
<p style="text-align: center;">JZ-10037 DP2 KRP41-S</p>  <p>For: PEGASUS DPS-2.3, 150 YAMATO DP2.3 SINGER 107G, 107W1, 107W5, 17 ADLER 91, 98 DURKOPP 252, 253, 254, 255, 264 SUNSTAR DPK-2</p> <p style="text-align: right;">7.93mm</p>	<p style="text-align: center;">JZ-10038 HSH-12-15LC KRT12-5BK</p>  <p>For: BROTHER LT2-B835-3, 5, 800 SEIKO LTW-27BK CONSEW 327R-1 (corner sewing machine)</p> <p style="text-align: right;">9.52mm</p>
<p style="text-align: center;">JZ-10039 DP2-815</p>  <p>For: BROTHER LH4-B815 BAS-500</p> <p style="text-align: right;">7.94mm</p>	<p style="text-align: center;">JZ-10040 HG12-15L(TRI)</p>  <p>For: BROTHER LT2-B842 (under trimming machine)</p> <p style="text-align: right;">9.52mm</p>
<p style="text-align: center;">JZ-10041 DP2-57(2) KRP 457</p>  <p>For: MITSUBISHI LZ720-780 SINGER 457G YULUN 547U205, 225</p> <p style="text-align: right;">7.94mm</p>	<p style="text-align: center;">JZ-10042 HG12-15L(H) KRT842H-S</p>  <p>For: BROTHER LT2-B841-5, B842-5 (heavy materials)</p> <p style="text-align: right;">9.52mm</p>
<p style="text-align: center;">JZ-10043 DP2-57(2LP) KRP457-W</p>  <p>For: SINGER 457G YULUN 547U435L (long hook point)</p> <p style="text-align: right;">7.94mm</p>	<p style="text-align: center;">JZ-10044 HG12-15LC KRT845BK</p>  <p>For: BROTHER LT2-B845</p> <p style="text-align: right;">9.52mm</p>
<p style="text-align: center;">JZ-10045 HSH-11-55 KRT11-5</p>  <p>For: JUKI LU-53, 55, 562 SEIKO STW-6, 7, 7B, 8, 8B, 8BV, 8M, 8BM, 8V, 8VM, 8VP, 8VPM, 8BVP, 8BVP, 8BVP SINGER 111W155, 156, 211G155, 156, 211U165, 166, 211U365/6, 211W151, 155 CONSEW 137, 139R-1, 224R-1, 225VMG, 266RVM-1 (slotted shank)</p> <p style="text-align: right;">9.52mm</p>	<p style="text-align: center;">JZ-10046 HSH-12-40 KRT12-4</p>  <p>For: SINGER 112W140, 145, 146</p> <p style="text-align: right;">7.94mm</p>
<p style="text-align: center;">JZ-10047 HSH-12-15 KRT12-5S</p>  <p>For: JUKI LH-51, 51-10, LH-516, 517, 518, LU-53-7, 562A SINGER 112W115-139</p> <p style="text-align: right;">9.52mm</p>	<p style="text-align: center;">JZ-10048 HSH-12-15M KRT12-5M</p>  <p>For: MITSUBISHI DN-260, 260-10, DN-265, 265-10, LT2-220-M, 2220M, 220, 2220, L UNICORN LT2-H320, H321 ABLE LT2-220ML</p> <p style="text-align: right;">9.52mm</p>



JZ-10049 HSH-12C KRT12-5MK

9.52mm

For: **MITSUBISHI** DN-275-10.10K
TAJIMA TMP-20
UNICORN LT2-H240-MOB
(corner sewing machine)



JZ-10050 HSH-12-15MM KRT12-5LM

9.52mm

For: **MITSUBISHI** DN260-22.262.265-22.267
LT2-220-B.220-BOB.2220-B
2220-BOB
NITAKA TC-B872
ABLE LT2-220BF



JZ-10051 HSH-12(2) KRT12-5J

9.52mm

For: **JUKI** LH-1152
SUNGOOD GC0501



JZ-10052 HSH-12MC KRT12-5LMK

9.52mm

For: **MITSUBISHI** DN-275-20.LT2-240-B.2240-B
NITAKA TC2-B875
SICAMA(TASICO)LT2-B875
UNICORN LT2-H240-BOB
(corner sewing machine)



JZ-10053 HSH-12-15(2)TR KRT12-5JCI

9.52mm

For: **JUKI** LH-1152-4.5
(under trimming machine)



JZ-10054 HSH-12-15MMJ KRT11-5LJS

9.52mm

For: **JUKI** LU-563
(slotted shank)



JZ-10055 HSH-12-62C(L) KRT12-5JK3-L

9.52mm

For: **JUKI** LH-1162
SICAMA(TASICO)SC-1162-5
(left hand)



JZ-10056 HSH-12-15MMJ(A) KRT11-5LJR

9.52mm

For: **JUKI** LU-563-3.LUH-520
YAKUMO 481L.482L
SINGER 212U539A.839A
211U567A.867A.211U867
EAGLE EA-156RB
(short gib. slot ted shank)



JZ-10057 HSH-12-62C(R) KRT12-5JK3-R

9.52mm

For: **JUKI** LH-1162
SICAMA(TASICO)SC-1162-5
(right hand)



JZ-10058 HSH-12-15MM(5) KRT-LS2-R

9.52mm

For: **BROTHER** LT2-B837
SEIKO LLW-7L.7BL.8L.8BL.LSW-6L
7L.7L-TA.LLWH-7L-TA
8L-TA.28BL-TA
TOYOTA AD331L.331LP.332L.332LP
CONSEW 244B.254B.255RB.333R.339R.



JZ-10059 HSH-12M-82C(L) KRT12-5LJK3-L

9.52mm

For: **JUKI** LH-1182
SICAMA(TASICO)SC-1182-5
SHANGGONG GD8-7
(left hand)



JZ-10060 HSH-12-15MMB(5) KRT-LS2-S

9.52mm

For: **BROTHER** LT2-B838
SEIKO LLW-27BL.27BL.28.28L.28BL
LSW-27L.27BL.27BLM.28L.
LTW-27BLM
CONSEW 333B.333RB-1.339.RB-1.
333RBL-1
(full gib. slotted shank)



JZ-10061 HSH-12M-82C(R) KRT12-5LJK3-R

9.52mm

For: **JUKI** LH-1182
SICAMA(TASICO)SC-1182-5
SHANGGONG GD8-7
(right hand)



JZ-10062 HG12M(BR) KRT872L

9.52mm

For: **BROTHER** LT2-B872



JZ-10063 HSH-12-15MM(V) KRT12-5LMC

9.52mm

For: **MITSUBISHI** DU-100-22.105-22.107.120-22
122.125-22.127.LU2-400B
420-BOB.4400.4420
(slotted shank)



JZ-10064 HG12MC(1) KRT875LK

9.52mm

For: **BROTHER** LT2-B875

因为用心,所以专业
BECAUSE THE HEART, SO PROFESSIONAL



JZ-10065 HPF-3114

FOR: PFAFF
 114,3114,3115



JZ-10066 KRT341-G

FOR: YAKUMO 34IL



JZ-10067 DP2-NG(790)

FOR: JUKI LBH 1790



JZ-10068 H12MC(2) 3188TR

FOR: JUKI LH3178-7,3128-7,3188-7



JZ-10069 2290

FOR: JUKI LZ 1280,2280 ,2290



JZ-10070 1720

JUKI
 GOLDENWHEEL CSL-1720



JZ-10071 818

FOR: JUKI 818



JZ-10072 HPF-151

FOR: PFAFF 120,122,141-146,142-720,
 151,175-196,191-196,871-893



JZ-10073 HPF-145

FOR: PFAFF 91-010850-91 W/O CA,141-146,
 175-196,871-893



JZ-10074 HPF-591

FOR: PFAFF 591



JZ-10075 HPF-1242

FOR: PFAFF 91-140539-91 W/O CAP,
 1242-720,1244-748



JZ-10076 HPF-545

FOR: PFAFF 541-546,551-555,591-596,
 542-720 (large capacity hook, full. gib)



JZ-10077 241

FOR: FENG YING FY-241-246-246V



JZ-10078 6-30

FOR: TYPICAL GC6-30



JZ-10079

FOR: TYPICAL GC6-20



JZ-10081 380 HSM-B(SU)
 KHS20-GTVG

FOR: SUNSTAR KM-380BL



JZ-10082 557 KRT211-L

HSH-12-15MM(S)
FOR: SINGER 211G557,558,556,
211U566,211G*104,
106,109,114,117,
212G539,541,
212G*2,106,114
(large capacity hook)



JZ-10083 DP2-818FR

FOR: BROTHER HM-8180



JZ-10084 HPF-1242TR

FOR: PFAFF 1242-720,1244-748



JZ-10085 KRT545-S HPF-545(B)

FOR: PFAFF 541-546,551-555
591-596,544-720



JZ-10086 KPT341-NHI

FOR: NITAKA TC-341-L
TC8370L,8371L,8372L,
8672L,9510L,9511L,6520L



JZ-10087 KRT341-NR 341HR

HYM-341AY
FOR: JUKI 21229752W/GAP LS-341N
MITSUBISHI LY3-6940-BOT
GOLDEN WHEEL CS-8233-NR,8243



JZ-10088 KRT19-R HSH-19

FOR: SINGER 110W-2,119W



JZ-10089 HSM-A1(TS)

FOR: BROTHER DB2-B797
JUKI DU-141NH,DU-580
SEIKO H-2B,H-2BL



JZ-10090 KRT8-BL HSH-31MMB(5)

FOR: SEIKO 13719 LCW-28BL,-8BL
SUNSTAR KM-390BL



JZ-10091 KR238 HPF238

FOR: PFAFF 91-064662-91W/0
BC 130,138,230,234,238
TAKING TK-735,735N



JZ-10080 253 HSH-32

FOR: SEIKO SKM-26,36,
SINGER 133K



JZ-10092 132 KRT-132

FOR: MITSUBISHI MG23E0121
SEIKO 1343C SK-2B,-6,-6F
SINGER 103123 132K
CONSEW SK-6,-7,-8
DURKOPP ADLER 265-21-142 265
GOLDER WHEEL CS-6500,6501,CSL-1800,1801



JZ-10093 133

HSH-33
KRT133

FOR: SEIKO 2530 CK-1
SINGER 103120 133K



JZ-10094 132M

KRT-132-M

FOR: SEIKO 1526 SKM-26,-36



JZ-10095 3823

信任源于品质, 服务彰显诚信

Confidence stems from quality, service demonstrate good faith



JZ-10301 BC-31-15

For: **SINGER** 31CL.(except 31-19,-20).
44-10,331k
CONSEW 30



JZ-10302 BC-DBZ (3)

(12mm Opening)
For: **ELTAC** 750 series
SINGER 20U
TAJIMA



JZ-10303 BC-LK(B2)

With NBL-101 Spring
For: **BROTHER** LK3-B430.-B431.-B432.-B433-B434
-B435.-B438.BAS-303-330
BAS-555



JZ-10304 BC-457(NS)

For: **CONSEW** 347,375R,376R
JUKI LZ-1285.-1286.-1287
MITSUBISHI LZ-720-11
BROTHER LZ2-B852.-853.-854
SINGER 457G,457U
STAGER DZ-S31.SZ-310
TOYOTA AD550.A551



JZ-10305 BC-LK(J3)

For: **JUKI** AMS-210A.-12A.LK-1850



JZ-10306 BC-LBH771

For: **JUKI** LBH-771.-772.-773.-781-4



JZ-10307 BC--DB1

For: **ADLER.BROTHER.CONSEW.**
HUSQVARNA.JANOME.JUKI.
MITSUBISHI.NECCHI.RICCAR.
TOYOTA.YAKUMO.YASIMA
SINGER 95.96.103.188U.195K.196K.245



JZ-10308 BC-DBM(1)

For: **BROTHER** D82B745-7.B797-5
TAJIMA TMB-E.TMB-W.TMW
JUKI DDL-201S
YAKUMO DBU-175L-3
CHINA GC6-7



JZ-10309 BC--DB1-NBL1

For: **ADLER.BROTHER.CONSEW.**
HUSQVARNA.JANOME.JUKI.
MITSUBISHI.NECCHI.RICCAR.
TOYOTA.YAKUMO.YASIMA
SINGER 95.96.103.188U.195K.196K.245



JZ-10310 BC-DBM(1)NBL3

Whit NBL-1303 Spring
For: **BROTHER** D82B745-7.B797-5
TAJIMA TMB-E.TMB-W.TMW
JUKI DDL-201S
YAKUMO DBU-175L-3
CHINA GC6-7



JZ-10311 BC--DBZ (1)

(18mm Opening)
For: **ADLER** 199.289.489
BARUDAN.BROTHER TZ1.LE2.BAS-400
JUKI LZ(except-405.-407.-581.-582.-583
-586.-1280.-1286.-1287)
NECCHI 533.535.720.721
STAGER DZ.SZ(except DZ-S31.SZ-21-1B
-5.-310)



JZ-10312 BC-6-5

For: **BROTHER** DB2-B745-5
JUKI DDL-210H
MITSUBISHI DB-325-22D.DY330-22D
TOYOTA D530-130.140
YAKUMO DBU-175L-1/1.680L
CHINA GC6-5-6-6-6-9



JZ-10313 BC-DBM(2)-NBL1

Whit NBL-1301 Spring
For: **CONSEW** 206RB.208RB
JUKI DNU-241H
SEIKO STH-38L.-7BL.-88L
YAKUWMO 280L.880LM



JZ-10314 BC-PF9076(14)

(14mm Opening)
For: **PFAFF** 130.138.230.238.335
SEIKO LSC-8BVC



JZ-10315 BC-DBM(Z2)

For: **TAJIMA**



JZ-10316 CP-12C(835)

For: **BROTHER** LT2-B835-3.5.800
JUKI LH-528
CONSEW 327R-1
TAJIMA TMP-20
ABLE HB-630
(corner sewing machine)

JINZEN®



JZ-10317 BC-PF9076
 (9mm Opening)
 For: **PFAFF** 133.134.232.234.260.300.331.332
 333.341.343.360.432.433.434.437
 438.439.461.463.465.467.481.483
 485.487.489
SEIKO LSC-8B.-8BV
ADLER 069
CONSEW 277



JZ-10318 CP-G12C(845)
 For: **BROTHER** LT2-B845
SUNSTAR KM-490



JZ-10319 BC-HA1
 For: **SINGER** 15k88.90.91



JZ-10320 CP-62C(1162)
 For: **JUKI** LH-1162.1162-4.5
SICAMA(TASICO) SC-1162-5.6
 (whit bobbin thread control spring)



JZ-10321 BC-107(2)
 With Split Tension Spring.
 For: **ADLER.BROTHER.CONSEW.DURKOPP.**
JULI.MITSUBISHI.PEGASUS.YAMATO.
SINGER 107G.107W3.14.15.50.143W1.2.3.
 18.307G2.



JZ-10322 CP-M82C(1162)
 For: **JUKI** LH-1182.1182-4.5
SICAMA(TASICO) SC-1182-5.6
 (large capacity cap with bobbin thread control spring)



JZ-10323 BC-107(2)-NBL
 With NBL-603 Spring.
 For: **ADLER.BROTHER.CONSEW.DURKOPP.**
JULI.MITSUBISHI.PEGASUS.YAMATO.
SINGER 107G.107W3.14.15.50.143W1.2.3.
 18.307G2.



JZ-10324 CP-G12MC(1)875
 For: **BROTHER** LT2B875
SUNSTAR KM-790-BL



JZ-10325 SC205H
 For: **JUKI** AMS220



JZ-10327 BC-310A
 For: **BROTHER**.BAS.-304.310.311.314.326.
 341.701
 (thin material)



JZ-10328 CP-HPF151(10159)
 For: **PFAFF**.151
GOLDEN WHEEL CS-861.862.8810.8820
YAKUMO 561-564



JZ-10330 BC-DBZ (1) -NBL6
 With NBL-406 Spring
 For: **ADLER** 199.289.489
BARUDAN.BROTHER TZ1.LE2.BAS-400
JUKI LZ(except-405.-407.-581.-582.-583
 -586.-1280.-1286.-1287)
NECCHI 533.535.720.721
STAGER DZ.SZ(except DZ-S31.SZ-21-1B
 -5.-310)



JZ-10331 BC-HZ3(NS)
 (12.3mm slot)
 With Ns tension spring



JZ-10332 BC-DBZ(2)
 (18MM OPENING)
 FOR : **JUKI** LZ-586



JZ-10333 BC-DBM(Z1)
 For: **CONSEW** 175.176.ellac 900.1800
 Stager sz-21-1B.-21-5
TOYOTA D530.-18e.-30p.-101.-110.-120
SEIKO lzh.evl



JZ-10334 LS-341
 For: **PFAFF** 1242-720B. C. D 1242-74B
 B. C. D 1244-720 B544-720 B. D.
 551-555 (SL) 551-553 (SL)

OUR QUALITY, YOUR TRUST



JZ-10335 BC-DBM(Z1)NBL3

FOR: CONSEW 175, 176, ELTAC 900,1800
SERIES SZ-21-1B, -21-5
TOYOTA D530,-18E, -30P, -101, -110,-120
SEIKO LZH,EVL



JZ-10336 CP-M697

FOR: DURKOPP 697



JZ-10337 181

FOR: MITSUBISHI PLK-A1710



JZ-10338 CP-G12MC(1)TR

S09280-001TR



JZ-10339 BC-DB1(G)

GOLD HANDER



JZ-10340 BC-PF3114

FOR: PFAFF 144, 155, 116, 3114, 3116



JZ-10341 INDUSTRIAL USE BC-DBZ(3)

(12MM OPENING)
FOR: ELTAC 750 SERIES,
SINGER 20U
TAJIMA



JZ-10343 BC-9076(TG)-NBL6

PFAFF/DUPKOPP TYPE
WITH NBL-806 SPRING
FOR: PFAFF



JZ-10345 INDUSTRIAL USE LARGE TYPE

For: JUKI AMS-205CGL



JZ-10346 181

FOR: MITSUBISHI PLK-A1710



JZ-10347 245 CP-M245



JZ-10348 BC-DBM(Z1)

FOR: CONSEW 175,176,ELTAC 900,1800
STAGER SZ-21-1B,-21-5
TOYOTA D530,-18E,-30P,-101,-110,-120
SEIKO LZH,EVL



JZ-10349 HSM-A(5)

FOR: SEIKO STH-3BL,6BL,7BL,8BL,
CONSEW:206RB,306RB



JZ-10350 BC-DBM(ZL)NBL3

FOR: CONSEW 175,176,
WITH NBL-1303 SPRING
LARGE CAPACITY



JZ-10351 LH-11520

FOR: JUKI LH-1152



JZ-10352 LH-527

FOR: JUKI LH-527,LUH-521,526,527
MITSUBISHI,
DN-275-20,
CORNER SEWING MACHINE LARGE
CAPACITY CAP

因为用心,所以专业

BECAUSE THE HEART, SO PROFESSIONAL



JZ-10353 LZ-2280

FOR:LZ-2280 GOLDEN WHEEL S-2200



JZ-10354 LBH-790

FOR:JUKI LBH-790 137-29769



JZ-10355 1.7倍大



JZ-10356 CP-HPF144TR

FOR: PFAFF. 144
GOLDEN WHEEL CS-61118.T.BT
CS-61128.T.BT
SEIKO PWB-8GWC.FLLC
SUNSTRA KM-867-7



JZ-10357 DDL-545

FOR:PFAFF



JZ-10358 双丝机1720

FOR:SINGER110W,118W,119W,236W,
GOLDEN WHEEL CSL-1720



JZ-10359 810内并

FOR: HOOK 810,820



JZ-10360 526

FOR:LU-1565,LUH-521,LUH-526



JZ-10361 241

B1837-241-H00



JZ-10362 175 BC-DBM(Z1)-NBL3

FOR:CONSEW175,176,ELTAC900,1800,SERIES,
STAGER SZ-21-1B,TOYOTA D530,
SEIKO LZH. EVL



JZ-10363 307 BC-HZ3(NS)

FOR: SINGER 307



JZ-10364 210D

FOR: JUKI LK1910,1920,1930,AMS-210D



JZ-10365 SINGER 反向 125291

125291



JZ-10369 BC-1306

SPS-B1306



JZ-10367

FOR:BC-DB1-NBL6 SPRING
BC-DB1-8



JZ-10370 SC-180J



JZ-10371 3倍 BC-HST(2)

FOR: JUKI LK-1941 14436257



JZ-10372 大人子绣花 BC-DBM(Z1)-NBL3

FOR: CONSEW SERIES 175, 176, ELTAC900, 1800
TOYOTA SZ-21-1B, -21-5
SEIKO D630, -18E, -30P, -101, -110, -120
LZH, EVL



JZ-10373 BC-DBM(2)-NBL4

WITH NBL
FOR: TAJIMA



JZ-10374 BC-DBM(2Z)-NBL3

BC-DBM(2Z)-NBL3
WITH NBL
FOR: TAJIMA



JZ-10375 LH-527 CP-12MC



JZ-10376 815TR LP-G12MC(1)TR



JZ-10377 1182 CP-M82C

FOR: JUKI LH-1182, 1182-4.5
SICAMA (TASICO) SC-1182-5.6
(LARGE CAPACITU CAP WITH
BOBBIN THERAD CONTROL SPRING)



JZ-10378 845TR CP-G12C-TR

FOR: BROTHER LT2-8845



JZ-10379 BC-DBM(1)-NBL3

FOR: MITSUBISHI LY2-380-BIT, PLK-1006,
1410, 4510, PLX-20JR



JZ-10380 BC-6-5-NBL

BC-DBM-NBL3
WITH NBL
FOR: BROTHER DB2-B745-5
JUKI DDL-210H



JZ-10381 BC-457-NBL



JZ-10382 BC-LBH771-NBL

WITH NBL
FOR: JUKI LBH-771, -772,
-773, -781-4



JZ-10383 591



JZ-10384 BC-NJ380



JZ-10385 BC-DLN

DMN-530-4
B1837 041 OAO



JZ-10386 761 BC-107(2)

FOR: JUKI LBH761-763



JZ-10387 3114 BC-PF3114

FOR: PFAFF 144, 155,
116, 3114, 3116



JZ-10388 814 BC-DP2(3B)

FOR: BROTHER
LH814, 2, 3, 4, 102



JINZE 梭





JINZEN®



**HSH-7-3
KSP7-3I**
JZ-10680



GB4-1A
JZ-10681



GB4-1
JZ-10682



KSP-204N
JZ-10683



GA5-1
JZ-10702



SINGER 974
JZ-10701



421326
JZ-10366



2972
JZ-10697



2971
JZ-10698



HPF-5870
JZ-10699



HPF-28
JZ-10700



GA3-1
JZ-10703



210E
JZ-10704



210D
JZ-10705



430D
JZ-10706



181
JZ-10707



1850
JZ-10708



430
JZ-10709



SH280
JZ-10710



SH205
JZ-10711



SH311
JZ-10712



430H A/B
JZ-10713



1306
JZ-10714



SH181
JZ-10715



SH180
JZ-10716



JAH 105
JZ-10717



125293
JZ-10718



多功能家用机
JZ-10719



HPF-3114
JZ-10720



125292 反向
JZ-10721

JINZEN®



JZ-10801 1850



JZ-10802 1900



JZ-10803 MITSUBISHI
2520

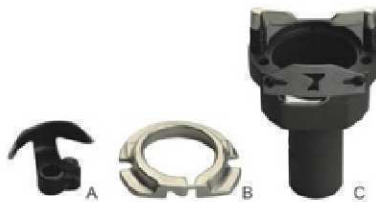

JZ-10804 430D



JZ-10805 1900A

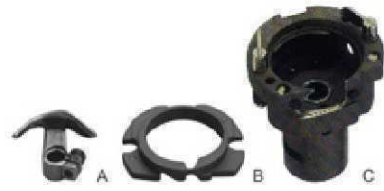

JZ-10806 210D

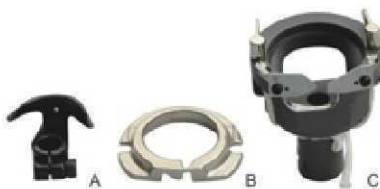

JZ-10807 430

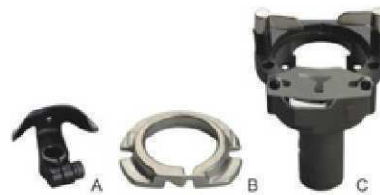

JZ-10808 430E



JZ-10809 311EL

BOBBINS



JAI-1



974 塑料



40264A



40264 车制



40264

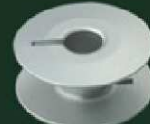

9033A



9033



55623A



55623AS



55623AS 深槽



55623A



159158-001



B1827-280-000



B1827-280-000 B



203470A



203470B



203470



272152



272152Y

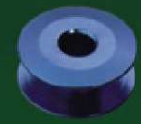

272152 BLUE



18034A



18034



B1811-771-000Y



B1811-771-000



270010



270010 S

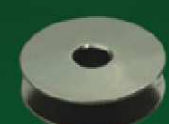

146025-001



GA3-1



138-12102 1900A



JAI-1 107#



112781



B1805-205-000

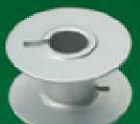

159613-0-01

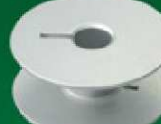

9910 罗拉车



S15665-001



1182 双针车



155484



GA5-1



GB4-1



特大



102-31603



5810



JZ-11201

other size can be manufactured
可订制各种规格

JINZEN® BAND KNIFE

JINZEN STRAIGHT KNIFE AVAILABLE SIZE

2200mm	2450mm	2800mm	2950mm	3000mm	3460mm
3500mm	3550mm	3555mm	3600mm	3650mm	3680mm
3700mm	3850mm	3860mm	3920mm	3960mm	4000mm
4050mm	4120mm	4150mm	4220mm	4250mm	4350mm
4450mm	4460mm	4500mm	4550mm	4560mm	4630mm
4760mm	4720mm	4870mm	4920mm	4950mm	5280mm
5360mm	5420mm	5480mm	5500mm	5650mm	5940mm



JZ-11222
Ø50MM



JZ-11223
Ø65MM



JZ-11224
Ø75MM



JZ-11225
Ø70MM



JZ-11226
修边机



JZ-11227
Ø90MM



JZ-11228
Ø90MM



JZ-11229
Ø100MM



JZ-11230
Ø100MM



JZ-11231
Ø110MM



JZ-11232
断布机



JZ-11233
80C1-61



JZ-11234
1430370



JZ-11235
80C1-39



JZ-11236
R 5 1/4M59



JZ-11237
R 6W NO.16



JZ-11238
R 6W(#18) NO.1427070



AAAAA

高速钢

AAA

合金钢

采用进口SKS7、M2高速钢以及SK2合金钢，采用目前最先进的生产工艺流程，配套有国内顶级的热处理设备，目前品种已达上千种，每个通过高精度检测影像仪器严格检测。

JINZEN knife Use imported SKS7 M2 high speed steel and SK2 alloy, with the most advanced production processes, top domestic heat treatment equipments, and so far already have more than 1000 types. Each knife has inspected under high-precision detective imaging device.

JINZEN®



JZ-11301



JZ-11300 合金钢

- 1/4
- 5/16
- 3/8
- 7/16
- 1/2
- 9/16
- 5/8
- 3/4
- 7/8
- 1"
- 1-1/8
- 1-3/16
- 1-3/8
- 1-1/2

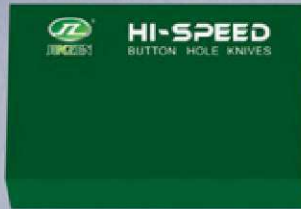

JZ-11302 高速钢

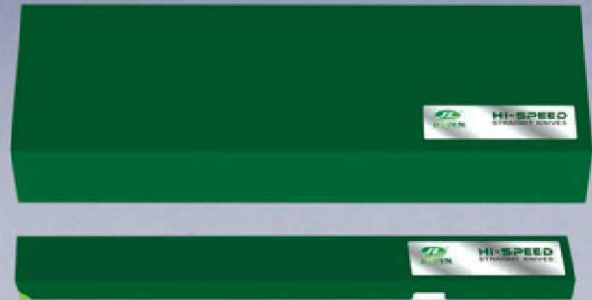

JZ-11303 SIZE: 5E 6E 7E 8E 9E 10E 12E 13E



JZ-11304



JZ-11305

JZ-11304 SIZE: 5E 6E 7E 8E 9E 10E 12E 13E

JZ-11305 SIZE: 5EW 6EW 7EW 8EW 9EW 10EW 12EW 13EW



JZ-11306

JINZEN®



SEWING MACHINE KNIVES



110-40052
DDL-5550-6



D2406-555-DOH
DDL-5550-6



114-09257
DDL-5550NH-7



114-09604
DDL-5550NH-7



D2402-555-BAO
DDL-555-5



D2406-555-B00
DDL-555-5



D2405-555-B00-B
DDL-555-5



110-40201
DDL-5550-6



B2421-280-0A0
LK-1850



B2424-280-000
LK-1850



B2424-210-000
AMS-210D



B2421-205-0A0
AMS-210C



B4121-052-A00
DLM-522



B4121-522-000
DLM-522



B4145-530-B00
DMN-530



B1130-026-000
MS-261



B1131-026-000
MS-261



B2406-373-0A0
MB-373



B2410-373-000
MB-373



141541-001
LH4-814



141543-001
LH4-B814



142419-001
LH4-B814



142416-001
LH4-B814



159274-001
LH4-B815



159276-001
LH4-B815



152901-001
LK3-B430



152905-001
LK3-B430



152906-101
LK3-B430



153219-001
LK3-B430



152897-201
LK3-B430



152981-001
LK3-B430



544533
299U



246061
NP-7



246071
NP-7



B2001-761-0A0
LBH-761



B2001-762-0A0
LBH-762



B2001-763-0A0
LBH-763



B2001-771-0A0
LBH-780



B2408-761-000
LBH-761



B2406-761-0A0
LBH-761



B2406-771-0A0
LBH-780



B2408-771-000-A
LBH-780



S35437-001
DH4-B980



S35092-001 20m/m
S37195-001 22m/m
S37196-001 24m/m
S37197-001 26m/m
S37198-001 28m/m
S37199-001 30m/m
S35093-001 38m/m



558 2564
558



558 2406 18m/m
558 2407 20m/m
558 2408 22m/m
558 2409 24m/m
558 2410 26m/m
558 2411 28m/m
558 2412 30m/m
558 2413 34m/m
558 2414 38m/m



10-3072-0-024
101



10-1069-0-051 7/8"
10-1069-0-052 1"
10-1069-0-054 1 1/4"
10-1069-0-055 1 3/8"
10-1069-0-056 1 1/2"
10-1069-0-060 2"



548886
299U



548762 1/2"
548763 5/8"
548764 3/4"
548765 7/8"
548766 1"
548767 1 1/8"
548768 1 1/4"
548769 1 3/8"
548770 1 1/2"
548771 1 5/8"

JINZEN®



CR26



CRL 103
C007J



425/6-4



111114-0-01



111113-0-01



象王/金轮
/高头车固定刀



B2421-210-000



B2424-210-A00



MG52A0838



MF02A0838



A-B2111417-556



10-001A-2700



716-154468-0-01



181LY-B110522020



B2410-373-000



JZ-11350



JZ-11351



548848



S02637-001



D2713



D2406-555-DOH



SB0598-001



152897-201



JZ-11352



S001701-0-01



JZ-11353



179458-05



S07525-000



40015996



301006



MAT-022040000



152897-201



110-42652



D2408-555-CA0



SA6989-001



S37672-101



S37671-101



S37675-101



S37676-101



32020505

OUR QUALITY, YOUR TRUST



B2421-210-AA0



S49988-001



MS03B0838



HV270080



FX0206010000DD



FX0227000000



SA3330-101



SA3335-001



SB1191-001



142419-001



13"1241"377"0A0



301008



MN50A0838



JZ-11354



253775



S02643-001 (正)



RU10



140888-0-01



JZ-11355



548865



179459-05



MF-40A1834



MG4080834



MF-40A1835



MG4080835



0271-001483



MF-40A2180



JZ-62008



MG52A0834



154575-0-01



MF02A0834



MF00A0834



S02646-001



S02645-001



91-264240-05



2111417-553-A



2111407-553-B



02520172-145-A-B



10-106A-2700
KM-250



181LY-B115421010



S075217-001



270950



3100512



253647



S00713-001



M03A0838



270010



350218



小型开袋机角刀 (日)



胜家切边刀
(镀钛T1)



胜家切边刀



KE044A



212807-113



S10605-0-01



JZ-11356



227682



246-2553 (加大)



246-2553



164-16109(T1)



164-16109



S16248-001
BAS-610



164-18709



MK10-004
(中刀)



548865



835-027
(修内里刀窄)



FY-171
(修内里刀宽)



JZ-11357



小型中刀
NK-202



166-07400



166-07301



166-07806-C2



166-07707-C1



246-996



246-996(右)



166-07608
166-07400



166-07509
166-07301



MK3、017 (左)



MK3、017 (右)



L48-S01584



S50259-101
HE-800A

SEWING MACHINE KNIVES



154590-001



千岛缝板舌



153219-001



153220



S00805-0-01



153222-001



152904-001



JZ-11358



JZ-11359



KB-270960



KB-271610



156150-001



S00718-001



MS02、A1、101



B2426-210-00BA
(有倒角)



156152-001(倒角)



156155-001



SA3645-201



SA3336-101



28×5.0×0.30mm



48×8.1×0.3mm



2652197



JZ-11360



MN50B0838-
MP41B0838



JZ-11361



3100513



05-658



U108



305-00300



350220



JZ-11362



10-002A-7507



S07526-201



225400



4.0/55.6



3.5/55.6



3.0/28.9



2.5/33.4



2.0/28.9



5.0/55.6



切带：切裤耳（上刀）



切带：切裤耳（下刀）

JINZEN®

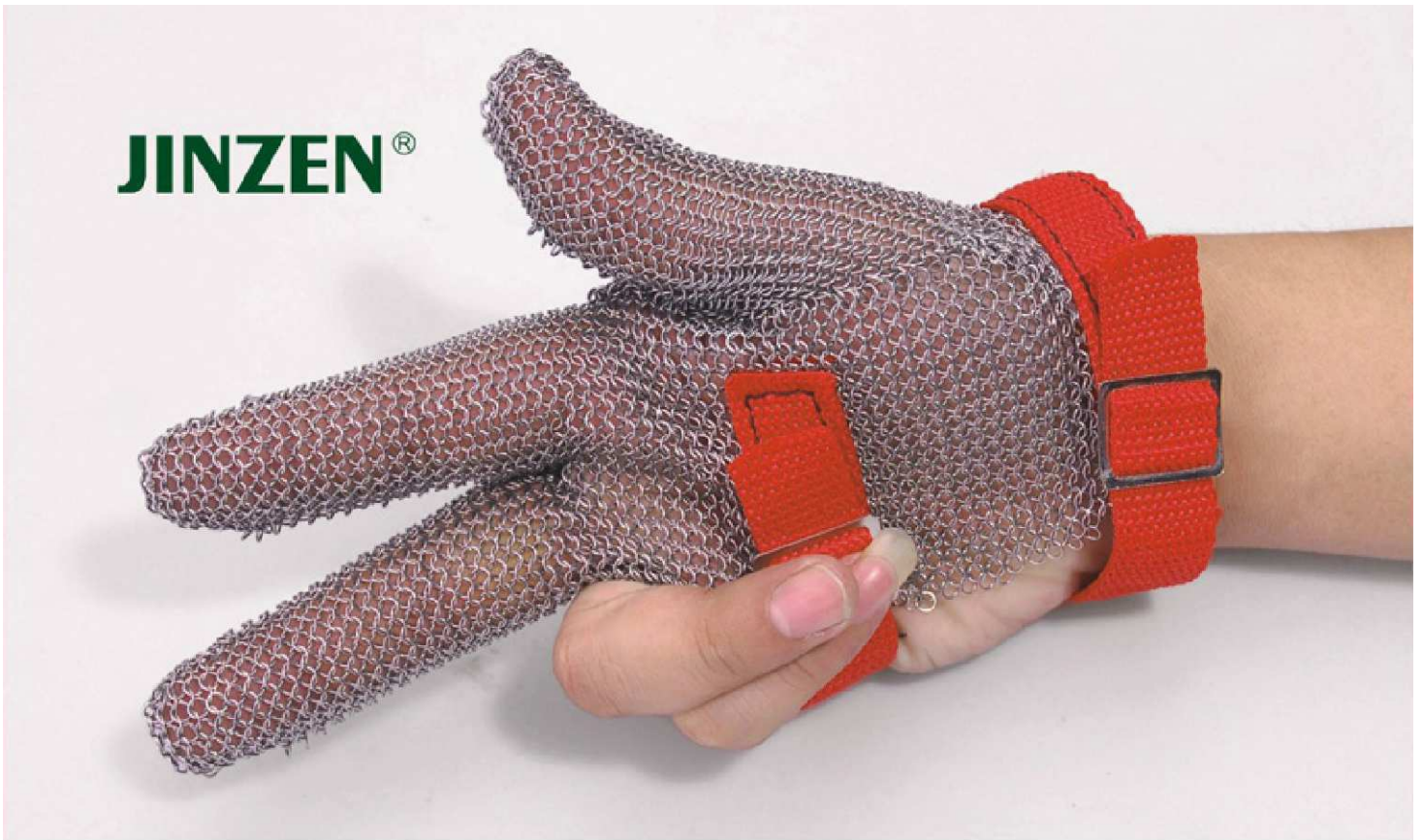

Glove Size	Size Number	Color Code	Traditional Glove Size	Hand Circumference
XXS	00	Brown	5 - 5.5	127 mm
XS	0	Green	6 - 6.5	152 mm
S	1	White	7 - 7.5	178 mm
M	2	Red	8 - 8.5	203 mm
L	3	Blue	9 - 9.5	229 mm
XL	4	Orange	10 - 10.5	254 mm



JZ-11401



CE 5-FINGER GLOVES
COMPLY EN1082

UL LISTED 73P8
SAFETY GLOVE



JZ-11402





JZ-11421



JZ-11422



JZ-11423

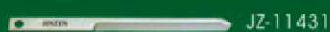

JZ-11434



JZ-11435



71 13/16	71 1/8
71 7/8	71 1/4
71 15/16	71 5/16
71 1	71 3/8
71 1-1/16	71 7/16
71 1-1/8	71 1/2
71 1-3/16	71 9/16
71 1-1/4	71 5/8
71 1-3/8	71 11/16
71 1-1/2	71 3/4



JZ-11436



JZ-11437



JZ-11438



JZ-11439



JZ-11440



JZ-11441



JZ-11448



JZ-11442



JZ-11443



JZ-11445



JZ-11446



JZ-11447



JZ-11449



JZ-11450

JINZEN[®]

NEEDLE PLATE 针板



JZ-11701



JZ-11702



JZ-11703



JZ-11704



JZ-11705



JZ-11706



JZ-11707



JZ-11708



JZ-11709



JZ-11710



JZ-11711



JZ-11712



JZ-11713



JZ-11714



JZ-11715



JZ-11716



JZ-11717



JZ-11718



JZ-11719



JZ-11720



JZ-11721



JZ-11722



JZ-11723



JZ-11724



JZ-11725



JZ-11726



JZ-11727



JZ-11728



JZ-11729



JZ-11730



JZ-11731



JZ-11732



JZ-11733



JZ-11734



JZ-11735



JZ-11736



JZ-11737



JZ-11738



JZ-11739



JZ-11740



JZ-11741



JZ-11742



JZ-11743



JZ-11744



JZ-11745



JZ-11746



JZ-11747



JZ-11748



brother



146730 146731
146732 146733
EF4-B511



146734 146735
146736 146737
EF4-B511



146781 146782
146783 146786
SO1711 SO1713
EF4-B531



146785
EF4-B531



146498
EF-B551



146501 146502
146503
EF4-B351



146504 146505
146510 147783
EF4-B551



146508
EF4-B551



146509
EF4-B551



S19161 S33024
S19154 S19155
EF4-N11



S33023 S19145
S19146 S25185
EF4-N11



S19153
EF4-N11



S19156 S25189
EF4-N11



S19149 S19150
EF4-N11



S25190 S19162
S19163 S25191
EF4-N21



S25527 S19170
S19169 S25193
EF4-N21



S19164 S19165
S19168
EF4-N21



S19166 S25192
S19167
EF4-N21



S20234 S20235
S20236 S25196
MA4-N31



S20231 S20232
S20233 S25197
MA4-N31



S19182 S19181
MA4-N31



S19183 S19184
MA4-N31



S19185 S19186
S19187
MA4-N31



S25204
MA4-N31



S25203
MA4-N31



S58581
MA4-N31



S08722 S08723
S08724
FD4-B272



S10572
DB2-B777



S10573
DB2-B777



145246
B814



S08730 S08731
S08732
FD4-B272



S08726 S08727
S08728 S08729
FD4-B272



S08740 S08741
S08742 S08743
FD4-B272



S08736 S08737
S08738
FD4-B272



S08718 S08719
S08720 S08721
FD4-B272

PEGASUS



204366 204367
204368 204369
L3 2-38



204528 204529
L32-86



204360A
204361A
L32-70



204294B 204039B
L32-30



204939 204940
204941
L32-48



204943 204944
204945
L32-80



205243
L52-34



205773 202617
202618
L52-01



202702 202675
R57-05



205465
L52-16



202546E
L52-17



208753 205255
L52-13



202554E
L52-13

JINZEN®



210783 210784
E52-211



210796 210797
E52-130



210789 210800
E52-130



210804 210805
E52-132



210809 210810
E52-131



210837 210838
210839
E32-420



210980 210981
210982
E32-542



210868
E32-451



210986 210987
E32-542



208674 208648



208675 208676



277500P40
277500P30
277500P50
Ex5204



277512P15
277502P15
Ex5204



277524T50
277524T60
EX3216H



277513R50
277513R40
Ex3216



277516R50
277516R50
Ex3216



277517R40
277517R50
Ex3216



277505R40
277505R30
277505R50
Ex5214



277519R40
Ex3244



257015B32 257015B40
257015B48 257017B56
W561-01



257016B48
W561-01



257018B56
257018B64
W561-01



257018B56-N
257090C56
W561-01



257018C56
W542-03



257018D56
W561-03



257090B56
W561-03



257007B56
257007B64
N644-03



257108B56
257108B64
W664-08



208276
208277
W61-01



257033B56
257033B64
W561-02



257030B48 257032B56
257032B64
W561-02



257050B40
W561-05



257050B48
W561-05



257053B56 257053B64
W561-05



257102B56
257102B64
W664-35

JUKI



R4200EODCOO
R4200EODDOA
MO-804



R4205EODEOO
MO-814



R4305E0EEEOO
R4305E0DEEOO
R4305E0DEEOA
MO-814



R4508EODCOO
MO-816



R4608E0FGOO
MO-816



R4612E0FGOA
MO-816



R4300E0FEEO
MO-804



R4308EODEEO
MO-814



R4200LOEEEO
MO-3316



R4300LOFEEO
MO-3304



R4305LOEEEO
MO-3314



R4508LOEGOO
MO-3316



R4608LOEGOO
MO-3316

信任源于品质，服务彰显诚信

Confidence stems from quality, service demonstrate good faith



R4100HOACOO
MO-2504



R4200HODDOO
R4300HODDOO
R4200HOFDOO
MO-2504



R4300HODEOO
R4300HOFEOO
MO-2504



R4305HODEOO
R4305HOFEOO
MO-2514



R4205HODEOO
R4205HODEAO
MO-2514



R4206-HODEOO
MO-2514



R4308HODEOO
R4308HOFEOO
MO-2514



R4508HODDOO
R4508HOFDOO
R4508HOFDOO
MO-2516



R4608HODFOO
MO-2516



R4608HOFGOO
MO-2516



R4612HOFGOO
R4612HOFBOO
MO-2516



R4608HODEOI



R4612HODEOI
MO-2516



R4200JODDOO
R4200JOEDOO
R4200JOEDAO
MO-3904



R4300JOEEOO
R4300JOFEEO
MO-3904



R4305JOEDOO
R4305JOFEEO
R4305JOFEEO
MO-3914



R4508JODDOO
R4508JOEDOO
R4508JOFDOO



R4612JOEDOO
R4612JOFEEO
R4612JOFGOO
MO-3916



R4608JODDOO
R4608JOEDOO
R4608JOFDOO
MO-3916



R4608JOFDOO



R4361FOGHOE
R4361FOHFOE
MF-890



B1137-352-000
MO-352



B1136-357-A00
B1136-357-B00
B1136-357-C00
MO-357



R4612LOFGOO
MO-3316



R4612LOHGOO
MO-3316



R4361FOGFOB
R4361FOHFOB
MF-870



50324B5.6
MF-7407



MS-1261 1/4



B2402-761-000
LBH-761



B1190-522-S00
DLM-5200 1/8
B1190-522-T00
DLM-5200 3/16



12422



B1192-522-000
DLM-5200



B2402-771-000
LBH-780



B1103-380-DOO
B1103-380-FOO 1/4
MH-380



MS-26 1/4

KANSAI



14-8540 14-8640
W8003D



14-8180 14-8190
W8803D



14-763 14-764
DWK1602D



14-889



14-890
14-891



14-845 14-847
W8103



14-860 14-861
14-862
W8803C



14-896 14-897



14-801 14-802
W8003C



14-854C
DWK1803D



14-854D
DWK1803D



14-744B
DVK-1702D



14-855 14-865



14-745B 14-753

2014 JINZHEN IMPORT & EXPORT CO.,LTD.



14-858 14-868
DWK1803EMK



14-746 14-756
14-766
DWK1802F



14-856 14-866
DWK1803F



14-728 14-738
14-748 14-756
14-768
Y7102EMK



14-812 14-813



14-811
14-814



14-301 14-302
DPW-1302S



14-790 14-791



14-784
14-785



14-612



14-760 14-760H
B2000C



14-5530
1503PHD

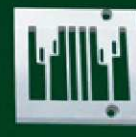

14-5900
1508P
1/4X7/8X1/4



14-5810
1508P
1/4X1X1/4

SIRUBA



E1826 E1827
FOO7E



E1524 E1525
FOO7E



E3826 E3826P
E3827 E3827P
COO7D



E3524P E3525P
COO7E



E1828
FOO7E



E2826P E2827P
FOO7



E4326 E4326P
E4327 E4327P
COO7D



E6326 E6327
FOO7E



E2635D
COO7D



E2625P E2626P
E2627P
COO7E



E4826
FOO7



E4836M E4837M
FOO7E



E3626P
COO7E



E589 E590
737



E589F
737



E591 E591A
747



E591B
747



E591E
747



E591F
747



E783 E784
737



E796 E797
737



E804 E805
747



E809 E919
E810 E920
747



E800
737



E934
737



E868 E870
757



E868D E871
767



E982
757



E986
757



E988
767



E989
767



E834
757



E853
757



E851
757

灌注東方文化 提煉永久品質
鑄就金振品牌 服務全球客戶

Yamato



34564 34565 34566
DCZ-503



2048000



32666
32667
DCE-200



34893 34894
DCE-200



32671 32673
32672
DCE-203



33353 32578
dce-220W



35334
DCE-341



34598 34585
DCE-520



33541 36570
DCE-361



33545 36590
DCE-361C



Y21768 21769
Z5003



Y21774
Z5003



Y21781
Z5020



21787
Z5020



Y21812 Y21813
Z6000



Y2022 E6000



2108000
2108001
HZ8000H



2108002
AZ8003H



2108003
AZ8003H



2108006 2105014
AZ8020H



2108006 2108014
AZ8020H



2108013



2108006B



2108064
Az8000



2108062



2108050
2108051



2108052
2108053
2108076



90166 90167
DW-100 DW-1350
94800 94801
94802



93170 93171
93172 VF-2400



3108133 3108134
3108135
VC-2700



95260 95261
95262
DV-1409



95278 95279
DW-1509



3208096
3208097
VF-2539



3208093
3208094
VF-2539



94801C



94801D Y3108134D
DN-2500 VC-2700



94801-N
VF-2500
VC-2700



94801B
VF-2500



Y3508003



Y3508021



3508019



Y3118023 256
Y3118024 264
Y3118025 366
VC-3711



3508100



3008025
VF-2503



95234
VF-1403



95085
VF-2503



94210 94211
94212
VF-2403



94281 90556
90557 VF-2403
DW-303

91764 91765
94901 94901
84902 DW-103
DW-1353

JINZEN[®] GAUGE SET

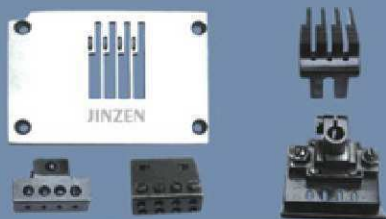

1404P 4N 1/4 3/16 5/16 3/8
1412P 4N 1/2 7/16 1 1/4 1 3/8

JZ-12101

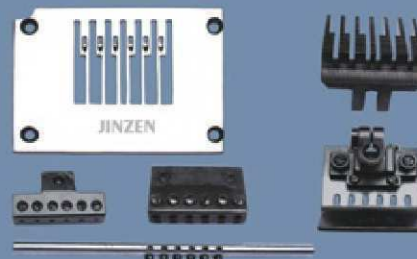

1404/1412P 6N 1/4 3/16 5/16 3/8

JZ-12102

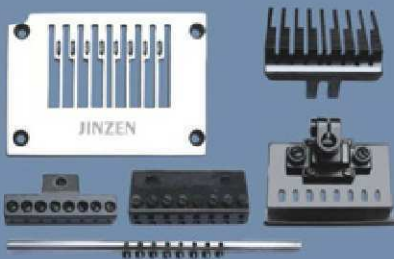

1404P 8N 1/4 3/16 5/16 3/8
1412P 8N 1/4 3/16 5/16 3/8

JZ-12103

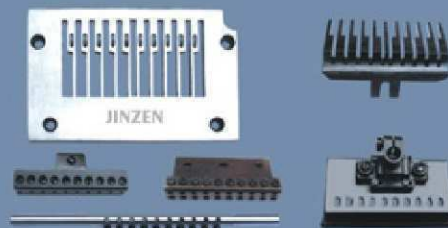

1404/1412P 10N 1/4 3/16
MH-380 1/8 5/32 3/16 7/32 1/4
5/16 3/8 1/2 5/8

JZ-12104



1404P 11N 3/16 11N x 1/8
1412P 11N 3/16 11N x 1/8 11N x 1/4

JZ-12105



1404P 12N 3/16 1/8
1412P 12N 3/16 1/8 1/4

JZ-12106

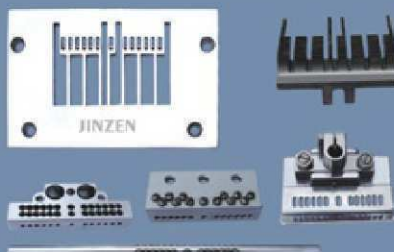

1412P 13N 1/8 13N x 3/16 13N x 1/4

JZ-12107



1404P 15N 1/8
1412P 15N 1/8

JZ-12108

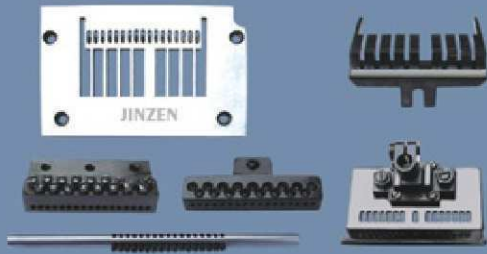

1404P 17N \times 1/8
JZ-12109

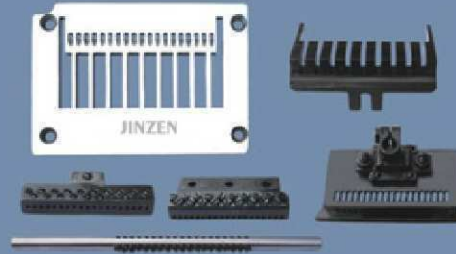

1412P 19N \times 1/8
JZ-12110

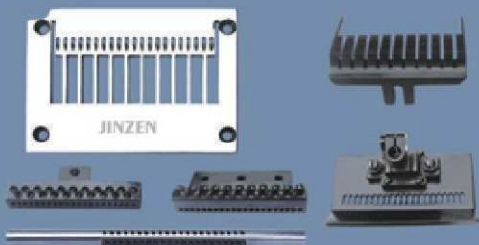

1412P 21N \times 1/8
JZ-12111

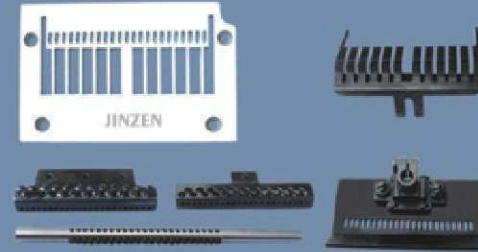

1412P 23N \times 1/8
JZ-12112

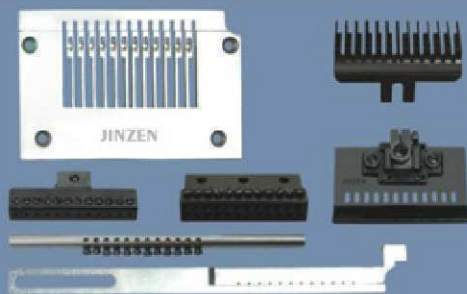

12N JZ-12113

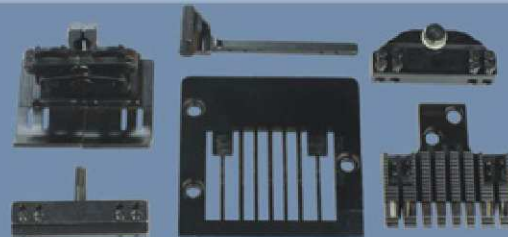

JUKI 1410
JZ-12114

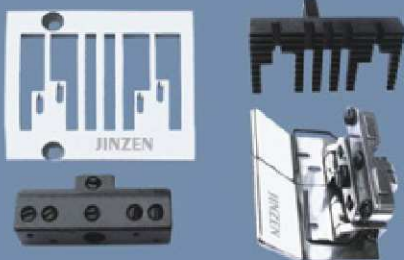

1508P
JZ-12115

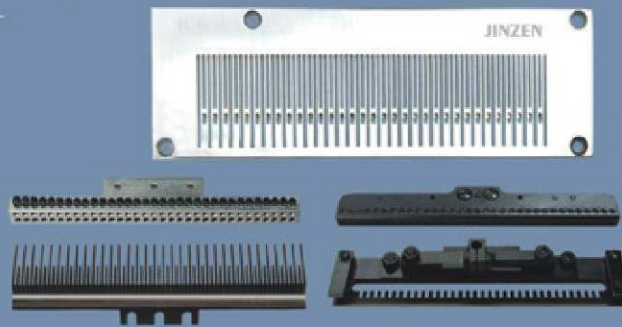

JZ-12116 33N



1702 JZ-12117

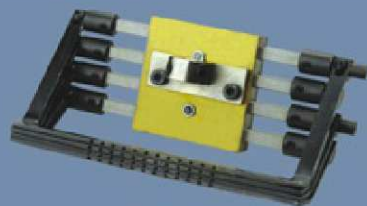

12N 摆线架
JZ-12118

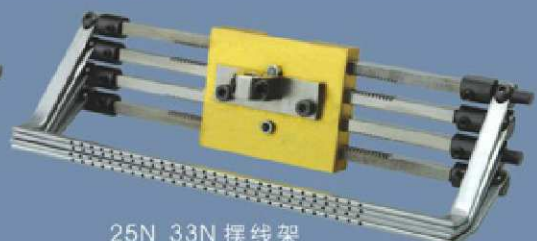

25N 33N 摆线架
JZ-12119

JINZEN®

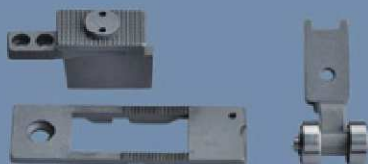

JZ-12199 双针模板机针位



JZ-12200 日星针位



LH515 (831) 1/8 5/32 3/16 7/32 1/4 5/16
3/8 5/8 1/2 3/4 7/8 1"
JZ-12201



LH1162 1/8 5/32 3/16 7/32 1/4 5/16
3/8 5/8 1/2 3/4 7/8 1"
JZ-12202



LT2-B845 1/8 5/32 3/16 7/32 1/4 5/16
3/8 5/8 1/2 3/4 7/8 1" 1 1/4
JZ-12203



B845-TR 1/8 5/32 3/16 7/32 1/4 5/16
3/8 5/8 1/2 3/4 7/8 1"
JZ-12204



LH3168 1/8 5/32 3/16 7/32 1/4 5/16
3/8 5/8 1/2 3/4 7/8 1"
JZ-12205



LH3168-7 1/8 5/32 3/16 7/32 1/4 5/16
3/8 5/8 1/2 3/4 7/8 1"
JZ-12206



G020202 1/8 5/32 3/16 7/32 1/4 5/16
3/8 5/8 1/2 3/4 7/8 1"
JZ-12207

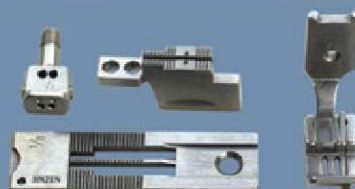

21010 1/8 5/32 3/16 7/32 1/4 5/16
3/8 5/8 1/2 3/4 7/8 1"
JZ-12208



双针切割针位组 1/8 5/32 3/16 7/32 1/4 5/16
3/8 5/8 1/2 3/4 7/8 1"
JZ-12209



DU 针位 1/8 5/32 3/16 7/32 1/4 5/16
3/8 5/8 1/2 3/4 7/8 1"
JZ-12210



JZ-12211 MS-26



JZ-12212 MS-19



JZ-12213 B926

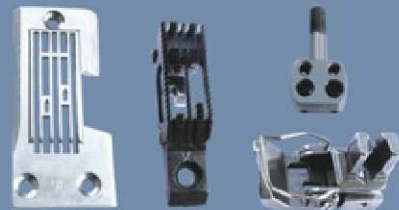

JZ-12214 DT6-927



JZ-12215 DT6-B928



JZ-12216 MS-1190



JZ-12217 MS1261



JZ-12218 DT6-B926/8A



JZ-12219 380单针



JZ-12220 380双针



JZ-12221 380



JZ-12222 380三针



JZ-12223 380三针平行



JZ-12224 假发针位组

JINZEN® GAUGE SET



JZ-12301

M03314

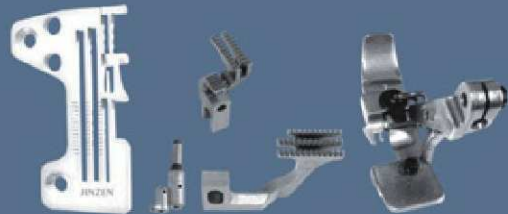

JZ-12302

M02516



JZ-12303

SH7000



JZ-12304

AZ8020



JZ-12305

531



JZ-12306

EX3200



JZ-12307

EF-021



JZ-12308

W500



JZ-12309

SIRUBA SIX STREAD



JZ-12310

JUKI 3616 SIX STREAD



JZ-12311 W600



JZ-12312 L32



JZ-12313 DCZ-220



JZ-12314 W562-5



JZ-12315 1302



JZ-12316 747



JZ-12317 M03614



JZ-12318 W600



JZ-12319 JUKI 2516 SIX STREAR



JZ-12320 PEGASUS SIX THREAD



JZ-12321 飞马包兜机针位

brother

DT6-B927
6.4mm(1/4)

DT6-B928
6.4mm(1/4)

DT6-B928-7
3.2mm x2(1/8 x 2)

DT6-B928-6
3.2mm x2(1/8 x 2)

DT6-B927-8
4.8mm(3/16)

中厚料
Medium materials

特厚料
Extra heavy materials

厚料
Heavy material

特厚料
Extra heavy materials

薄料、中厚料
Thin materials
Medium materials



S11508-101



150666-001



148864-001

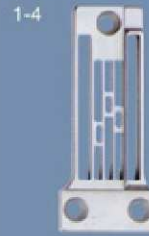

150667-001

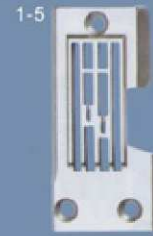

S05946-101



S40370-001



150673-001



148867-101



150675-101



S40369-001



106160-101



150668-101



148865-201



150672-101



S40355-001



183978-001



181716-001



183954-001



148973-001



148875-001



S06310-001









6-1

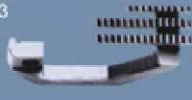

1:111443003
2:062671012
3:021670102
4:148876-001-0

EF4-B511-01		EF4-B531		MA4-B551	
0 x 3	0 x 4	5(2.2x5)	6(2.2x5)	063 (3x3)	065(5x5)
0 x 5	0 x 6	5(2.2x6)	6(2.2x6)	064 (3x4)	087 (5x5)
				064 (3x5)	092 (5x5)
1-1  146730-001 146731-001 146732-001 146733-001	1-2  146781-001 146782-001	1-3  146501-001 146502-001 146503-001	1-4  146504-001	1-5  146510-001	
2-1  146748-001	2-2  156036-001	2-3  146572-001	2-4  146573-001	2-5  146574-001	
3-1  146744-001 146577-001		3-2  146567-001 146577-001	3-3  146568-001 146577-001	3-4  146569-001 146577-001	
4-1  146884-001	4-2  146902-001	4-3  146871-101	4-4  146874-101	4-5  148013-101	
5-1  146773-001		5-3  146489-001	5-4  146491-001		

EF4-N11				EF4-N21	
01-4	01-5	01-4(B) 01-4(B)(0X4)	01-5(B) 01-5(C)	07-2	22-4(2.2x4) 22-5(2.2x5)
1-1  S19145-001 S19146-001	1-2  S19155-001 S19154-001	S19155-001		1-3  S19153-001	1-4  S25190-001 S19162-001
2-1  S19236-001	2-2  S19240-001			2-3  S25574-001	2-4  S19240-001
3-1  S19146-001	3-2  S19212-001			3-3  S19210-001	3-4  S19217-001
4-1  S19260-001	4-2  S29948-001	 S20494-001	 S20494-001	4-3  S19271-001	4-4  S25543-001 S19260-001
5-1					5-2  S20398-001

EF4-N21			MA4-N31	
27-5(2.2x5)	41-5(2.2x5)	45-5(2.2x5)	63-3(3x3) 63-4(3x4) 63-5(3x5) 63-5(3x7)	65-5(5x5)
1-1  S19166-001		1-2  S19169-001	1-3  S20234-001 S20235-001 S20236-001 S25196-001	1-4  S20232-001
2-1  S19237-101	2-2  S19240-001	2-3  S19244-101	2-4  S20245-001	2-5  S20244-001
3-1  S19202-001	3-2  S19212-001	3-3  S19219-001	3-4  S20242-001 S20243-001 S20241-101	3-5  S20240-001 S19223-101 S20239-101
4-1  S20494-001	4-2  S20494-001	4-3  S20494-001	4-4  S19313-201	4-5  S19317-101
5-1  S19287-201	5-2  S19293-001	5-3  S19297-001	5-4  S20404-001	5-5  S20406-001
	5-1  S20398-001			

brother

MA4-N31

65-6(5x6)

1-1

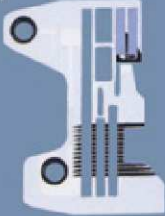

S20233-001

2-1



S20244-001

3-1



S20240-001
S19223-10
S20239-101

4-1



S19317-101

5-1



S20406-001

MA4-N31
FB-N310

92-5
92-6
92-7

5050-55-E3W(5x5)
5050-56-E3W(5x6)
5050-57-E3W(5x7)

4050-55-E3W(5x5)
4050-56-E3W(5x6)
4050-57-E3W(5x7)

1-2

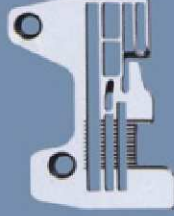

S19185-001
S19186-001
S19187-001

2-2



S19247-001

2-3



S38597-001

3-2



S19229-001
S19223-101
S19228-101

3-3



S38596-001
S19223-101
S38595-001

4-2



S19334-001

4-3



S30525-001

5-2



S21104-001

JUKI

MO-2414N

BE6(2x4)

1-3



R4305-HOE-E00

2-4



118-86504

3-4



118-82404
118-87106

4-4



118-76851

5-3



118-69658

MO-2504

OA4-150
OA4-150-FG
(1.6mm)

1-4



R4200-HOA-C00

2-5



B1657-804-O0T

3-5



118-82107
118-87007

4-5

















































118-76059

5-4





























118-69005































MO-2504			MO-2514	
OD4 OD4-FG(3.2) OE4-300(4.0mm)	OD4-200(3.2mm)	OD6-300 (0x3.2)	BO6-340 (2x3.2mm)	BD4-200 BD4-200-FG
1-1  R4200-HOD-DA0 R4200-HOE-DOO	1-2  R4200-HOD-DOO	1-3  R4300-HOD-EOO	1-4  R4305-HOD-EOO	1-5  R4205-HOD-E00
2-1  B1657-804-OOT		2-2  118-85100	2-3  118-86504	2-4  B1657-814-B0E
3-1  118-82107 118-87106		3-2  118-82206 118-87106	3-3  118-82404 118-87106	3-4  115-97101 118-87106
4-1  118-76158	4-2  118-81455	4-3  118-76356	4-4  118-79251	4-5  118-81554
5-1  118-69005			5-2  118-69658	5-3  118-69658

















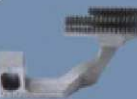











MO-2514	MO-2516		MO-2543	MO-3304E
BD4(2.0x3.2MM) BD4-FG	DD4-300(3.2x3.2mm) DF4-300(3.2x4.8mm)	FF6-500 (4.8x4.8mm)	FBD6-300 FBD6-300-FG (4.8x2.0x3.2)	OE4-40H (0x3.6)
<p>1-1</p>  <p>R4205-HOD-EA0</p>	<p>1-2</p>  <p>R4508-HOD-DOO R4508-HOF-DOO</p>	<p>1-3</p>  <p>R4612-HOF-GOO</p>	<p>1-4</p>  <p>R4612-HOD-E01</p>	<p>1-5</p>  <p>R4200-LOE-EOO</p>
<p>2-1</p>  <p>B1657-814-B0E</p>	<p>2-2</p>  <p>118-85209</p>	<p>2-3</p>  <p>118-85407</p>	<p>2-4</p>  <p>118-86009</p>	<p>2-5</p>  <p>12478004</p>
<p>3-1</p>  <p>115-97101 118-87106</p>	<p>3-2</p>  <p>118-82800 118-87403</p>	<p>3-3</p>  <p>118-83006 118-87304</p>	<p>3-4</p>  <p>118-84004 118-87403</p>	<p>3-5</p>  <p>12476008 12480000 12478004 124760A6 12476008 12480000</p>
<p>4-1</p>  <p>118-76851</p>	<p>4-2</p>  <p>118-77552</p>	<p>4-3</p>  <p>118-77750</p>	<p>4-4</p>  <p>118-78055</p>	<p>4-5</p>  <p>12466058</p>
<p>5-1</p>  <p>118-69658</p>	<p>5-2</p>  <p>118-70359</p>	<p>5-3</p>  <p>118-70458</p>	<p>5-4</p>  <p>118-70854</p>	<p>5-5</p>  <p>12465001</p>



MO-3304E		MO-3305E	MO-3314E	
OF6-50H (0x4.8)	DE4-40H/Z192 (0x3.1)	OE4-41H/L121 (0x3.4)	BE6-44H/G41/Q148 (2.2x3.6) BE6-40H(2.2 x 3.6)	BE6-42H/S170 (2.2x3.6)
1-1 R4300-LOF-EOO	1-2 R4200-L2E-EOO	1-3 R4200-LOE-DOO	1-4 R4305-LOE-EOO	1-5 R4305-LOE-EOA
2-1 12478806	2-2 12479101	2-3 12478301	2-4 12478103	2-5 12478103
3-1 12476701 12480109	3-2 12476800 12480000	3-3 12476305 12480307	3-4 12476107 12480109	3-5 12476602 12480109
12478806 124767A9 12480109	12479101 124768A8 12476800 12480000	12478301 124763A3 12476305 12480307	12478103 124761A5 12476107 12480109	12478707 124766A0 12476602 12480109
4-1 12466058	4-2 12466157	4-3 12466850	4-4 12466553	4-5 12466751
5-1 12465001		5-2 12465100		











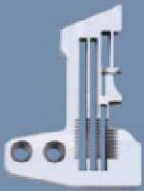
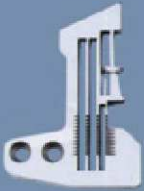





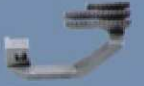

MO-3316E					MO-3343
DE-40H (3x3.8)	DE6-40H (3x3.8)	DE6-42H/S169 (3x3.8)	FF6-40H (4.8x4.8)	FF6-60H(4.8x4.8) FH6-60H(4.8x6) FF6-50H(4.8x6)	(4.8X2.2X3.2)
1-1  R4508-LOE-GOO	1-2  R4608-LOE-GOO	1-3  R4608-LOE-GOA	1-4  R4612-LOF-GOO	1-5  R4612-LOF-LOO R4612-LOH-LOO R4612-LOH-GOO	1-6  R4612-LOD-EOI
2-1  12478202	2-2  12478905	2-3  12478608	2-4  12478400	2-5  12478509	2-6  12478905
3-1  12476206 12480208	3-2  12476206 12480208	3-3  12476503 12480406	3-4  12476206 12480208	3-5  12476404 12480208	3-6  12476206 12480208
12478202 124762A4 12476206 12480208	12478905 124762B2 12476206 12480208	12478608 124765A1 12476503 12480406	12478400 124762C0 12476206 12480208	12478509 124764A2 12476404 12480208	12478905 124762B2 12476206 12480208
4-1  12470050	4-2  12470357	4-3  12470159	4-4  12470258	4-5  12473153	
5-1  12465407		5-2  12465506		5-3  12465605	











MO-3904	MO-3914	MO-3916		MO-3943	
OE4(0x4.0) OE4-FG(0x4.0)	BE6(2.0x4.0) BE6-FG(2.0x4.0)	OE4(3.2x4.0) OE4-FG(3.2x4.0)	DE6(3.2x4.0)	FF6(4.8x4.8) FF6-FG(4.8x4.8)	FBD6-347/G07/Q141 (4.8x2x3.2)
1-1  R4200-JOE-DOO	1-2  R4305-JOE-EOO	1-3  R4508-JOE-DOO	1-4  R4608-JOE-D00	1-5  R4612-JOE-DOO	1-6  R4612-J0D-E01
2-1  B1657-804-OOT	2-2  119-49906	2-3  121-72805	2-4  121-73209	2-5  121-73308	
3-1  118-82107 118-87106	3-2  119-49807 118-87106	3-3  118-82800 118-87403	3-4  118-82909 118-87106	3-5  118-84004 118-87403	
4-1  118-76158	4-2  121-52450	4-3  121-53755	4-4  121-54258	4-5  118-81257	
 118-76166	 121-52468	 121-53763	 121-54266	 118-81265	
5-1  121-48607	5-2  121-48706	5-3  121-49803	5-4  121-50306	5-5  121-50603	











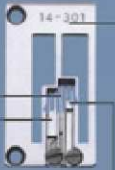













MO-6704	MO-6714		MO-6716		MO-6716
OE4-40H (0x4.0)	BE6-20H (2x4.0)	BE4-40H (2x4.0)	DE6-40H (3.2x4.0)	FF6-40H (4.8x4.8)	FF6-60H
1-1  R4200-J6E-D00	1-2  R4305-J6E-E00	1-3  R4205-J6E-E00	1-4  R4608-J6E-D00	1-5  R4612-J6F-D00	1-6  R4612-J6H-KOO
2-1  131-92802	2-2  121-72003	2-3  B1657-814-B0E	2-4  121-73209	2-5  121-73308	2-6  121-74207
3-1  131-91606 131-91309	3-2  121-71500 118-87106	3-3  115-97101 118-87106	3-4  118-82909 118-87403	3-5  118-84004 118-87043	3-6  121-71104
4-1  118-76158	4-2  118-76851	4-3  121-53755	4-4  121-54258	4-5  121-55552	
 118-76166	 118-76869	 121-53763	 121-54266	 121-55560	
5-1	5-2 122-75509	5-3	5-4 122-57507	5-5  121-50702	



MO-6743	MO-804	MH-380			
ID6-40H (4.8x2x3.2)	OD4(0x3.2)	1/8(3.2MM)	3/16(4.8MM)	1/4(6.4MM)	3/8(9.5MM)
1-1  R4612-J6D-E01	1-2  R4205-EOD-E00	1-3  B1103-380-B00	1-4  B1103-380-D00	1-5  B1103-380-F00	1-6  B1103-380-K00
2-1  121-73308	2-2  B1657-804-00C	2-3  B1613-380-B00	2-4  B1613-380-D00	2-5  B1613-380-F00	2-6  B1613-380-K00
3-1  118-84004 118-87403	3-2  B1656-804-000 B1658-804-000	4-3  B1509-038-BB0	4-4  B1509-038-DB0	4-5  B1509-038-FB0	4-6  B1509-038-KB0
4-1  118-78055  118-78063	4-2  B1507-814-0A0	5-3  B1406-019-BA0	5-4  B1406-019-DA0	5-5  B1406-019-FA0	5-6  B1406-038-KA0
5-1  122-75004	5-2  B1420-714-B00				

















UK1004S-01M	UK1014H-01M	UK1005S-10M	UK1004S-20F	UK1014H-40M
0x4	2x4 2x5	0x3 0x4	0x1.5	2x4 2x5
<p>1-1</p>  <p>57-001</p>	<p>1-2</p>  <p>57-041 57-051</p>	<p>1-3</p>  <p>57-011 57-021</p>	<p>1-4</p>  <p>57-031</p>	<p>1-5</p>  <p>57-061 57-071</p>
<p>2-1</p>  <p>57-201</p>		<p>2-2</p>  <p>57-211</p>		<p>2-3</p>  <p>57-201</p>
<p>3-1</p>  <p>57-105 57-106</p> <p>57-1010-1</p>		<p>3-2</p>  <p>57-115 57-116</p> <p>57-1110-1</p>	<p>3-3</p>  <p>57-115 57-126</p> <p>57-1210-1</p>	<p>3-4</p>  <p>57-105 57-116</p> <p>57-1310-1</p>
<p>4-1</p>  <p>57-3010-1</p>	<p>4-2</p>  <p>57-3310-1</p>	<p>4-3</p>  <p>57-3110-1</p>	<p>4-4</p>  <p>57-3210-1</p>	<p>4-5</p>  <p>57-3410-1</p>
<p>5-1</p>	<p>5-2</p>  <p>57-505</p>	<p>5-3</p>	<p>5-4</p>	<p>5-5</p>  <p>57-505</p>



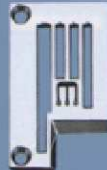







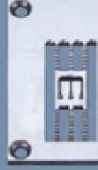

UK-1116S-01M UK-1116S-02M	UK-1116S-01H	UK-1116H-03X UK-1116H-03X	UK-1116S-30M	UK-1116S-30M	UK-1143H-90M
3x4 3x5	5x5	5x5 5x6	3x4	5x5	3x2x4
<p>1-1</p>  <p>57-002</p>	<p>1-2</p>  <p>57-012</p>	<p>1-3</p>  <p>57-022 57-032</p>	<p>1-4</p>  <p>57-042</p>	<p>1-5</p>  <p>57-012</p>	<p>1-6</p>  <p>57-052</p>
<p>2-1</p>  <p>57-202</p>	<p>2-2</p>  <p>57-212</p>	<p>2-3</p>  <p>57-222</p>	<p>2-4</p>  <p>57-232</p>		<p>2-5</p>  <p>57-242</p>
<p>3-1</p>  <p>57-107 57-108</p> <p>57-1020-1</p>	<p>3-2</p>  <p>57-117 57-108</p> <p>57-1120-1</p>	<p>3-3</p>  <p>57-127 57-118</p> <p>57-1220-1</p>	<p>3-4</p>  <p>57-137 57-108</p> <p>57-1320-1</p>	<p>3-5</p>  <p>57-147 57-108</p> <p>57-1420-1</p>	<p>3-6</p>  <p>57-117 57-108</p> <p>57-1120-1</p>
<p>4-1</p>  <p>57-3020-1 57-3120-1</p>	<p>4-2</p>  <p>57-3220-1</p>	<p>4-3</p>  <p>57-3320-1</p>	<p>4-4</p>  <p>57-3420-1</p>	<p>4-5</p>  <p>57-3520-1</p>	<p>4-6</p>  <p>57-3620-1</p>
<p>5-1</p>  <p>57-504</p>	<p>5-2</p>  <p>57-506</p>		<p>5-3</p>  <p>57-504</p>	<p>5-4</p>  <p>57-506</p>	<p>5-5</p> 

PX302-4W	DVK1702B	DVK1702BK	WX8700D WX8800D	RX9700D RX9800D	RX9700A RX9800A
	(2x6.4)	(2x6.4)	(3x5.6) (3x6.4)	(3x5.6) (3x6.4)	(3x5.6) (3x6.4)
<p>1-1</p>  <p>14-3310-1 14-3320-1 14-3330-1 14-3010-1</p>	<p>1-2</p>  <p>14-763</p>	<p>1-3</p>  <p>14-760</p>	<p>1-4</p>  <p>14-890 14-891</p>		
<p>2-1</p>  <p>15-361</p>	<p>2-2</p>  <p>15-704</p>	<p>2-3</p>  <p>15-760</p>	<p>2-4</p>  <p>15-805 15-807</p>	<p>2-5</p>  <p>15-855 15-857</p>	
<p>3-1</p>  <p>15-301</p>	<p>3-2</p> 	<p>3-3</p> 	<p>3-4</p>  <p>15-843 15-844</p>	<p>3-5</p>  <p>15-856 15-858</p>	
<p>4-1</p>  <p>17-3610-1</p>	<p>4-2</p>  <p>17-7620-1</p>	<p>4-3</p> 	<p>4-4</p>  <p>17-7680-1 17-7690-1</p>	<p>4-5</p> 	
<p>5-1</p>  <p>12-3150-1</p>	<p>5-2</p>  <p>12-2290-1</p>	<p>5-3</p>  <p>12-2200-1</p>	<p>5-4</p>  <p>12-8380-1 12-8390-1</p>	<p>5-5</p>  <p>12-8180-1 12-8190-1</p>	



B2000	B2000C	DLR1508P-E	1404P	1404PL
1/4"(2x6.4)	(2x6.4)	1/4x1x1/4	1/4x4N 3/16x4N	1/4x6N 3/16x6N
<p>1-1</p> <p>14-763</p>	<p>1-2</p> <p>14-760</p>	<p>1-3</p> <p>14-581</p>	<p>1-4</p> <p>14-4180-0 14-4170-0</p>	<p>1-5</p> <p>14-4430-0 14-4420-0</p>
<p>2-1</p> <p>15-704</p>	<p>2-2</p> <p>15-760</p>	<p>2-3</p> <p>15-581</p>	<p>2-4</p> <p>15-4180-0 15-4170-0</p>	<p>2-5</p> <p>15-4430-0 15-4420-0</p>
<p>3-1</p> <p>17-7620-1</p>	<p>3-2</p>	<p>3-3</p> <p>17-5810-1</p>	<p>3-4</p> <p>17-4800-1 17-4170-1</p>	<p>3-5</p> <p>17-4430-1 17-4420-1</p>
<p>4-1</p> <p>12-2290-1</p>		<p>4-2</p> <p>12-5810-1</p>	<p>4-3</p> <p>12-4180-1 12-4170-1</p>	<p>4-4</p> <p>12-4430-1 12-4420-1</p>
			<p>5-3</p> <p>19-4180-0 19-4170-0</p>	<p>5-4</p> <p>19-4430-0 19-4420-0</p>
			<p>6-4</p> <p>18-4180-0 18-4170-0</p>	<p>6-5</p> <p>18-4430-0 18-4420-0</p>

DVK1702D V7002D		DWK1802D W8002D		DVK1703D/V7003D DWK1803D/W8003D		DVK1702DE V7002DE		DWK1802DE W8002DE		DVK1703DE/V7003DE DWK1803DE/W8003DE	
1/8" (2x3.2) 5/32" (2x3.2)		3/16" (2x4.8) 7/32" (2x5.6) 1/4" (2x6.4)		7/32" (3x5.6) 1/4" (3x6.4)		1/8" (2x3.2) 5/32" (2x4.0)		3/16" (2x4.8) 7/32" (2x5.6) 1/4" (2x6.4)		7/32" (3x5.6) 1/4" (3x6.4)	
1-1 		1-2 		1-3 		1-4 					
14-724 14-734		14-744 14-754 14-764		14-854 14-864		14-725 14-735		14-745 14-755 14-765		14-855 14-865	
2-1 		15-723		15-724		15-723					
3-1 		15-753		15-755		15-753					
15-755											
DVK1702F DWK1802F V7002F			DVK1703F DWK1803F V7003F			WX8802F			WX8803F		
1/8" (2x3.2) 5/32" (2x4.0)		3/16" (2x4.8) 7/32" (2x5.6) 1/4" (2x6.4)		7/32" (3x5.6) 1/4" (3x6.4)		1/8" (2x3.2) 5/32" (2x4.0)		3/16" (2x4.8) 7/32" (2x5.6) 1/4" (2x6.4)		7/32" (3x5.6) 1/4" (3x6.4)	
4-1 		4-2 		4-3 		4-4 		4-5 		4-6 	
14-726 14-736		14-746 14-756 14-766		14-856 14-866		14-726 14-736		14-746 14-756 14-766		14-856 14-866	
5-1 		5-2 		5-3 		15-729		15-813		15-811	
15-729		15-726 (15-727)									
6-1 		6-2 		6-3 		15-758		15-814		15-812	
15-758		15-756									

WX8803C	WX8703D WX8803D	WX8802D	DVK1702E	DVK1703E
7/32" (3x5.6) 1/4" (3x6.4)	7/32" (3x5.6) 1/4" (3x6.4)	2x3.2 2x4.0	3/16" (2x4.8) 7/32" (2x5.6)	7/32" (3x5.6) 1/4" (3x6.4)
1-1 	1-2 	1-3 	1-4 	1-5 
14-860 14-862	14-820 14-819	14-806 14-807 14-808	14-745 14-755 14-765	14-855 14-865
2-1 	2-2 	2-3 	2-4 	
15-823	15-807	15-805	15-704	
3-1 	3-2 	3-3 	3-4	
15-808	15-808	15-806		

Kingtex

PEGASUS























SH6005-C32-C52	SH6034-D03-M45	L52-01	L52-05	L52-05S1	L52-17
M16	M45	0x3 0x4	2x3 2x4	2x3	0x4
<p>1-1</p>  <p>TP605C32 TP605C52</p>	<p>1-2</p>  <p>TP634D03</p>	<p>1-3</p>  <p>202617 205773</p>	<p>1-4</p>  <p>202702 202675</p>	<p>1-5</p>  <p>202546E</p>	
<p>2-1</p>  <p>DF85209</p>	<p>2-2</p>  <p>DF86108</p>	<p>2-3</p>  <p>204730-BF</p>	<p>2-4</p>  <p>204693-BF</p>	<p>2-5</p>  <p>204676-BF</p>	
<p>3-1</p>  <p>FD60828 AF60874</p>	<p>3-2</p>  <p>FD60842 AF60875</p>	<p>3-3</p>  <p>204729ABF 204674 208090-BF</p>	<p>3-4</p>  <p>204692A-BF 204674-BF</p>	<p>3-5</p>  <p>204675A 204674 208078-BF</p>	
<p>4-1</p>  <p>PF605C32</p>	<p>4-2</p>  <p>PF634D03</p>	<p>4-3</p>  <p>208525 201152E/201155C</p>	<p>4-4</p>  <p>208525 201230C/201396B 201230C/201310A</p>	<p>4-5</p>  <p>208525 208730/208731</p>	<p>4-6</p>  <p>208525 201230C/201224B</p>
<p>5-1</p>  <p>NC605032</p>	<p>5-2</p>  <p>NC605048</p>	<p>5-3</p>  <p>209670-92</p>	<p>5-4</p>  <p>208905</p>	<p>5-5</p>  <p>209670-92</p>	



L52-16	L52-13	L52-51 L52-52	L32-31	L32-34	L32-38
0 x 1.5	2 x 3 2 x 4	2 x 4	3 x 3 3 x 4	3 x 3 3 x 4	3 x 3 3 x 4 3 x 5
1-1 205465	1-2 205255 202554E	1-3 205243	1-4 204294B 204039B		1-5 204366 204367 204368
2-1 204730	2-2 204676-BF		2-3 208215	2-4 208217	2-5 208219
3-1 204729A 208912 208911	3-2 204675A 204674 208078-BF	3-3 204675A 204677 208079-BF	3-4 204248B 208059 208063	3-5 204394 208059 208064	3-6 204396 208060 208066
4-1 208525 201230C/205525	4-2 208525 208730/208731 208730/208732	4-3 208525 205253/201310A	4-4 208501		4-5 208504
5-1 209670-92	5-2 208905		5-3 208909		



L32-70	L32-48 F32-48 F32-49	L32-86	L32-359	M752-01	M752-17
5 x 5 5 x 6	3 x 3 3 x 5	5 x 5 5 x 6	3 x 2 x 4	0 x 4	0 x 4
<p>1-1</p>  <p>204360A 204361A</p>	<p>1-2</p>  <p>204939 204941</p>	<p>1-3</p>  <p>204528 204529</p>	<p>1-4</p>  <p>208648</p>	<p>1-5</p>  <p>205773</p>	<p>1-6</p>  <p>202546E</p>
<p>2-1</p>  <p>208215</p>	<p>2-2</p>  <p>204420</p>	<p>2-3</p>  <p>208217</p>	<p>2-4</p>  <p>208219</p>	<p>2-5</p>  <p>204730-BF</p>	<p>2-6</p>  <p>204676-BF</p>
<p>3-1</p>  <p>204248B 208059</p> <p>208063</p>	<p>3-2</p>  <p>204931 208061</p> <p>208074</p>	<p>3-3</p>  <p>204394 208059</p> <p>208064</p>	<p>3-4</p>  <p>204396 208060</p> <p>208066</p>	<p>3-5</p>  <p>204729ABF 204674</p> <p>208090-BF</p>	<p>3-6</p>  <p>204675A 204674</p> <p>208078-BF</p>
<p>4-1</p>  <p>208502</p>	<p>4-2</p>  <p>208508</p>	<p>4-3</p>  <p>208506 208955</p>	<p>4-4</p>  <p>208649</p>	<p>4-5</p>  <p>208525</p> <p>201152E/201155C</p>	<p>4-6</p>  <p>208525</p> <p>201230C/201224B</p>
<p>5-1</p>  <p>208910</p>	<p>5-2</p>  <p>208909</p>	<p>5-3</p>  <p>208910</p>	<p>5-4</p>  <p>208965</p>	<p>5-5</p>  <p>209670-92</p>	

M752-16S1 M752-16S2	M752-180	M752-53A M752-54A	M752-13	M752-23B
0 x 1.5	0 x 4	0 x 4	2 x 3 2 x 4	2.5 x 4.5
1-1  205465	1-2  202618A	1-3  205321	1-4  205255 202554E	1-5  209508-45
2-1  204730	2-2  204730A16F	2-3  204693	2-4  204676-BF	2-5  209417A25F
3-1  204729A 208912 208911	3-2  204729B16F 204674 208090A16F	3-3  204692A 204677 208083	3-4  204675A 204674 208078-BF	3-5  209416-25F 204674 209509-25F
4-1  208525 201230C/205525	4-2  208525 201473B/301433	4-3  208525 212182/210371	4-4  208525 208730/208731 208730/208732	4-5  208525 201230C/208050A
5-1  209670-92		5-2  209670	5-3  208905	5-4  208906A92

M752-55A	M752-181	M732-36	M732-38	M732-70
2 x 4	2 x 4	3 x 3 3 x 4 3 x 5		5 x 5 5 x 6
1-1  202983	1-2  209732	1-3  204366 204367 204368		1-4  204360A 204361A
2-1  204693-BF	2-2  209742-16F	2-3  208218	2-4  208219	2-5  208215
3-1  204692ABF 204677 208083-BF	3-2  209741-16F 204677 209740-16F	3-3  204395 204425 208065	3-4  204396 208060 208066	3-5  204248B 208059 208063
4-1  208525 212182/201310A	4-2  208525 205253/209734	4-3  208501	4-4  208504	4-5  208502
5-1  208905	5-2  208905A92	5-3  208909B92		5-4  208910B92















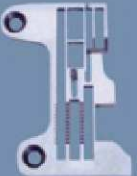
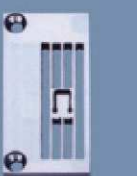
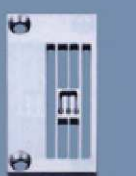







M732-86	M732-48	M732-48P2	M732-354 M732-355	M852-16S2
5 x 5 5 x 6	3 x 4	3 x 4	3 x 2 x 4	0 x 1.5
1-1  204528 204529	1-2  204940	1-3  204940	1-4  208648	1-5  2054651
2-1  208217	2-2  204420	2-3  204420	2-4  208219	2-5  2047300
3-1  204394 208059 208064	3-2  204931 208061 208074	3-3  204931 208061 208074	3-4  204396 208060 208066	3-5  204729A0 2089120 2089110
4-1  208506 208955	4-2  208508	4-3  204502A	4-4  208649	4-5  274018-92B0 201230C0/2055250
5-1  208910B92	5-2  208909B92	5-3  208909B92	5-4  208965B92	5-5  179630-920











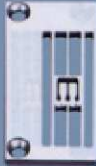

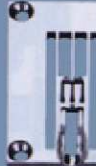



M852-01	M852-17	M852-13	M832-38	M832-70
0 x 4	0 x 4	2 x 4 2 x 5	3 x 4	5 x 5
<p>1-1</p>  <p>2057731</p>	<p>1-2</p>  <p>202546E1</p>	<p>1-3</p>  <p>202554E1 202499E1</p>	<p>1-4</p>  <p>2043671</p>	<p>1-5</p>  <p>204360A1</p>
<p>2-1</p>  <p>204730-BF0</p>	<p>2-2</p>  <p>204676-BF0</p>	<p>2-3</p>  <p>204676-BF0</p>	<p>2-4</p>  <p>2082190</p>	<p>2-5</p>  <p>2082150</p>
<p>3-1</p>  <p>204729ABF0 2046740</p> <p>208090-BF0</p>	<p>3-2</p>  <p>204675ABF0 2046740</p> <p>208078-BF0</p>	<p>3-3</p>  <p>208675ABF0 2046740</p> <p>208078-BF0</p>	<p>3-4</p>  <p>2043960 2080600</p> <p>2080660</p>	<p>3-5</p>  <p>204248B0 2080590</p> <p>2080630</p>
<p>4-1</p>  <p>274018-92B0</p> <p>201152E0/201155C0</p>	<p>4-2</p>  <p>274018-92B0</p> <p>201230C0/2103710</p>	<p>4-3</p>  <p>274018-92B0</p> <p>2087300/2087321</p>	<p>4-4</p>  <p>2771180</p>	<p>4-5</p>  <p>2771190</p>
<p>5-1</p>  <p>179630-920</p>	<p>5-2</p>  <p>277022-920</p>	<p>5-3</p>  <p>277027-921</p>	<p>5-4</p>  <p>277029-920</p>	











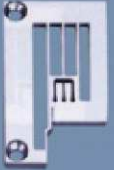













M832-86	EX5204-01/223K	EX5204-02/223K	EX5203-22/223K	EX5205-12/223K EX5203-12/223K
5x5	0x3 0x4	0x3 0x4 0x5	0x5 0x6	0x3 0x4
<p>1-1</p>  <p>2045291</p>	<p>1-2</p>  <p>277500P30 277500P40</p>	<p>1-3</p>  <p>277504R30 277504R40 277504R50</p>	<p>1-4</p>  <p>277504R50 277504R60</p>	<p>1-5</p>  <p>277500P30 277500P40</p>
<p>2-1</p>  <p>2082170</p>	<p>2-2</p>  <p>277302-16F</p>	<p>2-3</p>  <p>277305-16F</p>	<p>2-4</p>  <p>277302-16F</p>	
<p>3-1</p>  <p>2043940 2080590 2080640</p>	<p>3-2</p>  <p>277301-16F 277318-13 277300-16F</p>	<p>3-3</p>  <p>277304-16F 277318-13 277303-16F</p>	<p>3-4</p>  <p>277304-16F 277318A13 277303A16F</p>	<p>3-5</p>  <p>277301-16F 277318-13 277300-16F</p>
<p>4-1</p>  <p>2771220</p>	<p>4-2</p>  <p>274018-92B 201230C/210370 201230C/210371 201230C/210371</p>	<p>4-3</p>  <p>274018-92B 202799/210371 202799/210372</p>	<p>4-4</p>  <p>274018-92B 201152E/277115 201152E/277103</p>	
<p>5-1</p>  <p>277029-920</p>	<p>5-2</p>  <p>179630-92</p>			











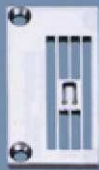

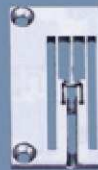









EX5204 -32R2/223L(K)	EX5204 -32R2/223L(K)	EX5212 -02/333K	EX5214 -53/333K EX5214 -53C3/333K	EX3216 -02/223K
0x1.5	0x1.5	2x3 2x4 2x5	2x4 2x5	3x4 3x5
1-1  277512P15	1-2  277502P15	1-3  277505R30 277505R40 277505R50	1-4  277505R40 277505R50	1-5  277513R40 277513R50
2-1  277302-16F	2-2  277305-16F	2-3  277325-16		
3-1  277301-16F 277309-13 277315-16F	3-2  277304-16F 277318-13 277303-16F	3-3  277324-16F 277318-13 277323-16F		
4-1  274018-92B 202799/205525	4-2  274018-92B 201230C/210503 201230C/210374 201230C/210374	4-3  274018-92B 277112/208651	4-4  277118	
5-1  179630-92	5-2  277022-92	5-3  277027-92		





































EX3216-03/233K		EX3216-03/233K		EX3215 EX3216 -04/435K		W561 W562-01 CB/CC			
3x4 3x5		5x5 5x6		5x5 5x6		2x3.2 2x4.0 2x4.8			
1-1		1-2		1-3		1-4		1-5	
	277517R40 277517R50		277516R50 277516R60		277524T50 277524T60		257015B32 257015B40 257015B48		257016B48
2-1		2-2		2-3		2-4			
	277330-16		277329-16		277339-25		257258-16F		
3-1			3-2			3-3			
	277328-16 277318-13 277327-16F			277338-25 277318-13 277337-25			257206-16F		
4-1		4-2		4-3		4-4		4-5	
	277118		277119		277122		257460-32 257460-40 257460-48		257461-48 257461-56 257461-64
5-1		5-2		5-3		5-4		5-5	
	277027-92		277028-92		277029-92		257517-32 257517-40 257517-48		257518-48 257518-56 257518-64





















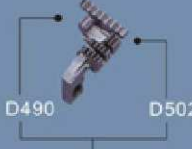

W561 W562-01 CB/CC		W562-01CA	W561-03 DB W562-03 DB	W562-03DC	W561 W562-02 BB/BC				
3x5.6 3x6.4		3x5.6	3x5.6 3x6.4	3x5.6	2x3.2				
1-1		1-2		1-3		1-4		1-5	
257018B56 257018B64		257018A56	257090B56 257090B64		257090C56	257029B32			
2-1		2-2		2-3					
257259-16F		257253-16F		257260-16F					
3-1		3-2		3-3					
257207-16F		257207-16F		257214-16F					
4-1		4-2		4-3					
257461-48 257461-56 257461-64		257461-56	257468-56 257468-64		257468-56	257317A32			
5-1		5-2		5-3					
257518-48 257518-56 257518-64		257518-56	257518-56 257518-64		257518-56	257517-32			











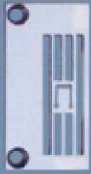

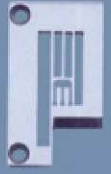













W561 W562-02 BB/BC		W562-05 BB		W561 W562-01 DB
2x4.0 2x4.8	3x5.6 3x6.4	2x3.2 2x4.0 2x4.8	3x5.6 3x6.4	4x6
<p>1-1</p>  <p>257030B40 257030B48</p>	<p>1-2</p>  <p>257033B56 257033B64</p>	<p>1-3</p>  <p>257049B32 257050B40 257050B48</p>	<p>1-4</p>  <p>257053B56 257053B64</p>	<p>1-5</p>  <p>257020-60</p>
<p>2-1</p>  <p>257261-16F</p>	<p>2-2</p>  <p>257262-16F</p>	<p>2-3</p>  <p>257266-16F 257267-16F 257267-16F</p>	<p>2-4</p>  <p>257268-16F</p>	<p>2-5</p>  <p>257256-16F</p>
<p>3-1</p>  <p>257215-16F</p>	<p>3-2</p>  <p>257216-16F</p>	<p>3-3</p>  <p>257220-16F 257221-16F 257221-16F</p>	<p>3-4</p>  <p>257222-16F</p>	<p>3-5</p>  <p>257203A-16F</p>
<p>4-1</p>  <p>257318A40 257318A48</p>	<p>4-2</p>  <p>257321A56 257321A64</p>	<p>4-3</p>  <p>257327A32 257328A40 257328A48</p>	<p>4-4</p>  <p>257331A56 257331A64</p>	<p>4-5</p>  <p>257491-60</p>
<p>5-1</p>  <p>257517-40 257517-48</p>	<p>5-2</p>  <p>257518-56 257518-64</p>	<p>5-3</p>  <p>257517-32 257517-40 257517-48</p>	<p>5-4</p>  <p>257518-56 257518-64</p>	<p>5-5</p>  <p>257513-60</p>

W664-01 CB		W664-03 FB		W664-02 BB	
2x3.2 2x4.0 2x4.8	3x5.6 3x6.4	3x5.6 3x6.4	2x3.2 2x4.0 2x4.8	3x5.6 3x6.4	
1-1  257015B32 257015B40 257015B48	1-2  257018B56 257018B64	1-3  257097B56 257097B64	1-4  257029B32 257030B40 257030B48	1-5  257033B56 257033B64	
2-1  257289-16F	2-2  259215-16F	2-3  257291-16F 257292-16F 257292-16F	2-4  257293-16F		
3-1  257242-16F	3-2  259103-16F	3-3  257244-16F 257245-16F 257245-16F	3-4  257246-16F		
4-1  257460-32 257460-40 257460-48	4-2  257461-56 257461-64	4-3  257468-56 257468-64	4-4  257317A32 257318A40 257318A48	4-5  257321A56 257321A64	
5-1  257517-32 257517-40 257517-48	5-2  257518-56 257518-64	5-3  257518-56 257518-64	5-4  257517-32 257517-40 257517-48	5-5  257518-56 257518-64	















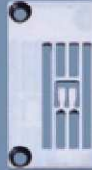
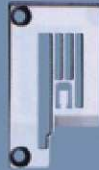













W664-34 AB	W664-02BA	W664-35 BB	737-504M2	
2x4.0 2x4.8	3x5.6 3x6.4	3x5.6 3x6.4	04(0x4)	04LFC-2(0x4)
<p>1-1</p>  <p>257100B40 257100B48</p>	<p>1-2</p>  <p>257033A56 257033A64</p>	<p>1-3</p>  <p>257102B56 257102B64</p>	<p>1-4</p>  <p>E800</p>	
<p>2-1</p>  <p>259202-16F</p>	<p>2-2</p>  <p>257253-16F</p>	<p>2-3</p>  <p>259203-16F</p>	<p>2-4</p>  <p>H445</p>	
<p>3-1</p>  <p>259100-16F</p>	<p>3-2</p>  <p>257207-16F</p>	<p>3-3</p>  <p>259101-16F</p>	<p>3-4</p>  <p>D440 D095 D575</p>	
<p>4-1</p>  <p>257485-40 257485-48</p>	<p>4-2</p>  <p>257321A56 257321A64</p>	<p>4-3</p>  <p>257486-56 257486-64</p>	<p>4-4</p>  <p>KS56 P253E/F371 P253E-3</p>	<p>4-5</p>  <p>KS56 P101/F371 P101-3</p>
<p>5-1</p>  <p>257517-40 257517-48</p>	<p>5-2</p>  <p>257518-56 257518-64</p>	<p>5-3</p>  <p>KG131</p>		















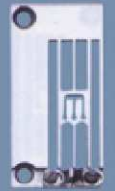













737-505F1		737-504M1		747-504M3		747-512M1		747-514M2			
03(0x3) 04(0x4)		15(0x4)		04(0x4)		24(2x4) 25(2x5)		24LF-B(2x4) 24TG-B(2x4)			
1-1		1-2		1-3		1-4		1-5		1-6	
E783 E784		E934		E919		E809 E810		E809		E805	
2-1				2-2							
H442				H445							
3-1		3-2		3-3		3-4		3-5			
D438	D674	D438	D912	D440	D674	D440	D095	D440	D674		
D569		D290		D574		D575		D574			
4-1		4-2		4-3		4-4		4-5			
KS56	KS56	KS56	KS56	KS56	KS56	KS56	KS56	KS56			
P152D/F155	P152D/F525	P152D-F155	P152D-F525	P253E/F374	P253E-F374	P101/F374	P101-F374	P254G/F504G	P254G-F504G		
P152D-3		P152D-A		P253E-4		P101-4		P254G-4			
5-1		5-2		5-3							
KG131		KG142-E				KG142					



























757-516M2		757-516X2		767-516M2	
35(3x5)	55(5x5)	56(5x6)	324(3x2x4)	524(5x2x4)	
1-1  E962	1-2  E966	1-3  E868	1-4  E989	1-5  E988	
2-1  H497	2-2  H500	2-3  H501	2-4  H497	2-5  H500	
3-1  D489 D502 D581	3-2  D490 D502 D582	3-3  D971 D502	3-4  D972 D502		
4-1  P504	4-2  P502	4-3  P955	4-4  P233-A	4-5  P255-A	
5-1  KG153	5-2  KG155	5-3  KG333	5-4  KG355		



























C007E -U222/CQ	C007E-W122/CH		C007E -W152/CZ	C007E -W222CQ	C007E -W332/CD
3x5.6	2x4.0	3x5.6 3x6.4	3x5.6	2x4.0	3x5.6
1-1  E4426P	1-2  E3524P	1-3  E3826P E3827P	1-4  E4326P	1-5  E4124P	1-6  E3626P
2-1  H3362	2-2  H4258 H4259	2-3  H3262	2-4  H3362	2-5  H4158	
3-1  D3216	3-2  D4206 D4207	3-3  D3216	3-4  D4206		
4-1  P2116	4-2  P0024	4-3  P0216 P0217	4-4  P2416	4-5  P1814	4-6  P1406
5-1  M4356	5-2  M4240	5-3  M4356 M4364	5-4  M4356	5-5  M4240	5-6  M4356



















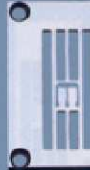

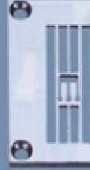

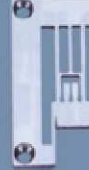









C007E -W332/CE	C007H-W122/CH C007H-W122/CH/UTP(UTP)		C007-W152/ CZ/UTP/RLO	C007H-W162 C007H-U162	C007H -W222/CQ
3x5.6	2x4.0 2x4.8	3x5.6 3x6.4	3x5.6	3x5.6 3x6.4	2x4.0 2x4.8
1-1  E2626P	1-2  E3524P E3525P	1-3  E3826P E3827P	1-4  E4326P	1-5  E3846 E3847	1-6  E4124P E4125P
2-1  H3159	2-2  H4258	2-3  H4258 H4259	2-3  H3262	2-4  H4258 H4259	2-5  H3362
3-1  D2107	3-2  D4206	3-3  D4206 D4207	3-3  D3216	3-4  D4206 D4207	3-5  D3216
4-1  P1406	4-2  P0024 P0025	4-3  P0216 P0217	4-4  P2416	4-5  P0226 P0227	4-6  P1814 P1815
5-1  M4356	5-2  M5240 M5248	5-3  M5356 M5364	5-4  M5356	5-5  M5356 M5364	5-6  M5240 M5248

F007H -W222/CQ	F007E -W122/UTG	F007E -W222/FQ		F007E -W322/FDC	F007E -W922/FW
3x5.6 3x6.4	2x4.0 2x4.8	3x5.6 3x6.4	3x5.6 3x6.4	3x5.6	4x6.0
1-1  E4426P E4427P	1-2  E1524 E1525	1-3  E1826 E1827	1-4  E3326 E3327	1-5  E4826	1-6  E1828
2-1  H3362 H3363	2-2  H1258	2-3  H1259	2-4  H1262	2-5  H1359	2-6  H1259
3-1  D3216 D3217	3-2  D1206	3-3  D1207	3-4  D1216	3-5  D1207	3-6  D1207
4-1  P2116 P2117	4-2  P0024 P0025	4-3  P0216 P0217	4-4  P2116 P2117	4-5  P1406	4-6  P2408
5-1  M5356 M5364	5-2  M4240 M4248	5-3  M4356 M4364		5-4  M4356	5-5  M4460















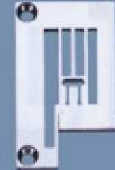













SC7300		SC7310		SF-7500/BN		AZ8000H		AZ8003H			
3 x 5.6 3 x 6.4		3 x 5.6 3 x 6.4		3 x 5.6 3 x 6.4		04(0 x 4)		03(0 x 3) 04(0 x 4)			
1-1		1-2		1-3		1-4		1-5		1-6	
GP-001320-00 GP-006766-00		GP-009973-00 GP-010244-00		GP-012184-00 GP-012185-00		2108000		2108002		2108003	
2-1		2-2		2-3		2-4		2-5		2-6	
GP-001357-00 GP-006770-00		GP-009972-00		GP-012180-00 GP-012186-00		2109000		2109007		2109005 2109009	
3-1		3-2		3-3		3-4		3-5			
GP-001356-00 GP-006769-00		GP-009971-00		GP-012179-00 GP-012985-00		2109001 2109067		2109006		2109067	
4-1		4-2		4-3		4-4		4-5		4-6	
AS-000288-00 AS-001705-00		AS-002970-00 AS-003073-00		AS-003712-00 AS-003713-00		2107032		2107300		2107301	
5-1		5-2		5-3		5-4					
GP-001295-00 GP-006765-00		GP-001295-00 GP-006765-00		GP-001295-00 GP-006765-00		2109100					

























AZ8020H		AZ8025H	AZ8500H		AZ8000G AZ6000H	AZ8020G AZ6020H								
Y5(2.4 x 5) Y6(2.4 x 6)			A4(3.2 x 4)	C5(5 x 5)	0 x 4	2.4 x 5 2.4 x 6								
1-1	 2108004 2108005		1-2	 2108050	1-3	 2108052	1-4	 2108000	1-5	 2108004 2108005				
2-1	 2109005 2109009		2-2	 2109050	2-3	 2109055	2-4	 2109000	2-5	 2109005 2109009				
3-1	 2109006 2109067		3-2	 2109051 2109052	3-3	 2109056 2109052	3-4	 2109001 2109052	3-5	 2109006 2109067				
4-1	 2107310 2107311		4-2	 2107308 2107309		4-3	 2107100	4-4	 2107102	4-5	 2157086	4-6	 2157057 2157058	
5-1	 2109101		5-2	 2109110	5-3	 2109112	5-4	 2159102		5-5	 2159102			



















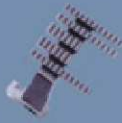

AZ8020G AZ6020H	AZ8500G AZ6500H		DV1250	DW1350	VF2400
2.4 x 5 2.4 x 6	A4(3.2 x 4)	C5(5 x 5)	MA(2 x 3.2) MB(2 x 4.0) MC(2 x 4.8)	MD(3 x 5.6)	132M(2 x 3.2) 140M(2 x 4.0) 148M(2 x 4.8)
1-1  2108004 2108005	1-2  2108050	1-3  2108052	1-4  93170 93171 93172	1-5  94801	1-6  93170 93171 93172
2-1  2109005 2109009	2-2  2109050	2-3  2109055	2-4  93394	2-5  3209001	
3-1  2109006 2109067	3-2  2109051 2109052	3-3  2109056 2109052	3-4  93395	3-5  3209000	
4-1  2157116 2157118	4-2  2157310	4-3  2157315	4-4  91131 91132 91133	4-5  90722	4-6  95580 95581 95582
5-1  2159102	5-2  2159111	5-3  2159112	5-4  93251 93252 93253	5-5  93257	5-6  3209100 3209101 3209102

VF-2200	VF-2300	VF-2203	VF2500	VF2403	VF2503
132M(2x3.2) 140M(2 x 4) 148M(2 x 4.8)	156M(3 x 5.6)	140M	156M(3 x 5.6)	140M-11(2 x 4.0)	156M-11(3 x 5.6)
1-1  3108130 3108131 3108132	1-2  3108134	1-3  3208103	1-4  94801	1-5  95234	1-6  95085
2-1  3209001	2-2  3209065	2-3  3209001	2-4  3209009		
3-1  3209080	3-2  3209064	3-3  3209000	3-4  3209008		
4-1  63318 63319 63320	4-2  64041-N	4-3  3207151	4-4  95587	4-5  95238	4-6  95089
5-1  93351 93352 93353	5-2  93357	5-3  93352	5-4  3209107	5-5  3209101	5-6  3209107

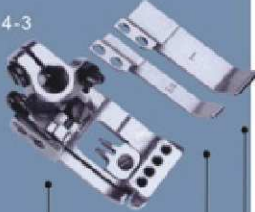
缔造全新品质，服务全球客户
Creates the brand-new quality, serves the global customers

VF2403	VF2503-21	VC2600	VC2700		VC2603
148M(2 x 4.8)	156M(3x 5.6) 164M(3x6.4)	132M(2x3.2) 140M(2 x4.0) 148M(2x 4.8)	156M(3 x 5.6)	164M(3 x6.4)	140M-11(2x4.0)
1-1  94283	1-2  3208108 3208109	1-3  93170 93171 93172	1-4  94801	1-5  94802	1-6  95234
2-1  3209005	2-2  3209065	2-3  3109000	2-4  3109000	2-5  3109002	2-6  3109020 3109022
3-1  3209004	3-2  3209064	3-3  3109001	3-4  3109001	3-5  3109003	3-6  3109021
4-1  94217	4-2  3207156 3207157	4-3  63318 63319 63320	4-4  64041-N	4-5  64042-N	4-6  95238
5-1  3209102	5-2  3209107 3209108	5-3  93351 93352 93353	5-4  93357	5-5  93358	5-6  93352

VC2703	VG-2700-132M	VG2700-140M	VG2700		
156M-11(3 x 5.6) 164M(3 x 6.4)	2 x 3.2	2 x 4.0	148M(3 x 4.8)	156M(3 x 5.6)	164M(3 x 6.4)
<p>1-1</p>  <p>95085 94902</p>	<p>1-2</p>  <p>3508000</p>	<p>1-3</p>  <p>3508001</p>	<p>1-4</p>  <p>3508002</p>	<p>1-5</p>  <p>3508003</p>	<p>1-6</p>  <p>3508004</p>
<p>2-1</p>  <p>3109020 3109022</p>	<p>2-2</p>  <p>3509004</p>		<p>2-3</p>  <p>3509004</p>		
<p>3-1</p>  <p>3109021</p>	<p>3-2</p>  <p>3509005</p>		<p>3-3</p>  <p>3509005</p>		
<p>4-1</p>  <p>95089 94909</p>	<p>4-2</p>  <p>3507000-N</p>	<p>4-3</p>  <p>3507002-N</p>	<p>4-4</p>  <p>3507050-N</p>	<p>4-5</p>  <p>3507052-N</p>	<p>4-6</p>  <p>3507054-N</p>
<p>5-1</p>  <p>93357 93358</p>	<p>5-2</p>  <p>93351</p>	<p>5-3</p>  <p>93352</p>	<p>5-4</p>  <p>93356</p>	<p>5-5</p>  <p>93357</p>	<p>5-6</p>  <p>93358</p>

VC3611	VG-3721		VE2713	
156M(3 × 5.6) 156M(3 × 6.4)	148S1(3 × 4.8)	156S1(3 × 5.6)	156S-2-K4N (3 × 5.6)	156L-2-TIN 156L-TIN (3 × 5.6)
1-1  3118025 3118026	1-2  3508099	1-3  3508100	1-4  3158094	1-5  3158082
2-1  3119020	2-2  3509036		2-3  3159034 3159019	2-4  3159034 3159012
3-1  3119021	3-2  3509037		3-3  3159037	
4-1  3117124 3117126	4-2  3507064	4-3  3507064 3107273 3107274	4-4  3507052-N	
5-1  93357 93358	5-2  93356	5-3 	 93357	

Ijamoto

PEGASUS

SHING LING

FD-62G-01MR

FS700

SL-700

1-1

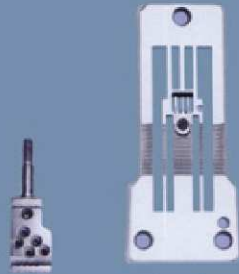

68053

68490

1-2

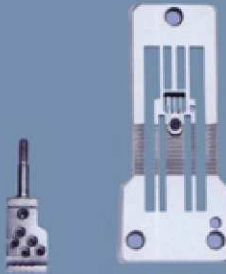

2L0004

236001

1-3

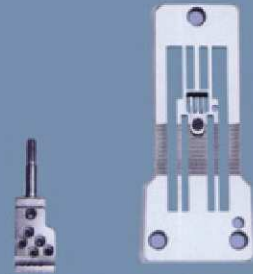

JO824452

ZO859

2-1



68095

68096

2-2



236200

2362010

2-3



J16165

J16235

3-1



3027092

3-2



3Q0009

3-3



J2201



于仁薄料
JZ-12350



于仁厚料
JZ-12351



大和双切加长
JZ-12355

大和加长单切
JZ-12356

大和单切6.0
JZ-12357

大和单切5.2
JZ-12358

大和双切
JZ-12359



大和薄料
JZ-12352



大和厚料
JZ-12353



星菱薄料
JZ-12354



飞马单切薄料
JZ-12360

飞马单切厚料
JZ-12361

飞马双切薄料
JZ-12362

飞马单切宽加长
JZ-12363

飞马单切窄加长
JZ-12364

JINZEN®

TEFLON 铁氟龙系列



JZ-12401



JZ-12402



JZ-12400



JZ-12403



JZ-12404



JZ-12405



JZ-12406



JZ-12407



JZ-12408



JZ-12409



JZ-12410



JZ-12411



JZ-12412

2014 JINZHEN IMPORT & EXPORT CO.,LTD.



JZ-12497



JZ-12498



JZ-12499



JZ-12500



JZ-12501



JZ-12502



JZ-12503



JZ-12504



JZ-12505



JZ-12506



JZ-12507



JZ-12508



JZ-12509



JZ-12510



JZ-12511

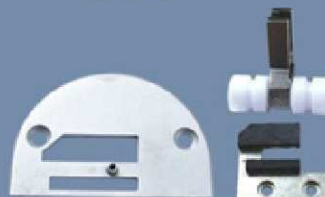

JZ-12512

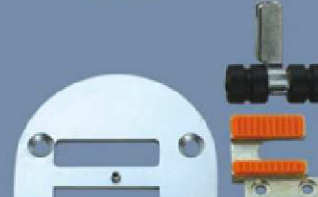

JZ-12513



JZ-12514



JZ-12515



JZ-12516

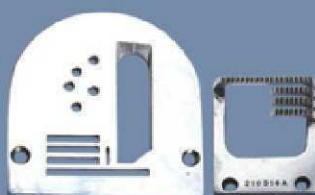

JZ-12517

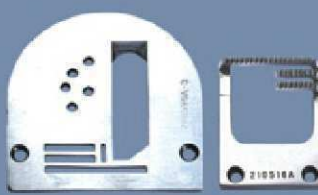

JZ-12518



JZ-12519

以客为尊的服务理念!
THE SERVICE IDEA OF GIVING MANY REGARDS TO CUSTOMS

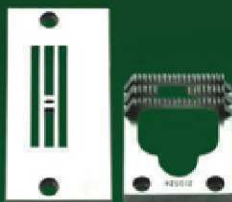

JZ-12520
210604 / 210524

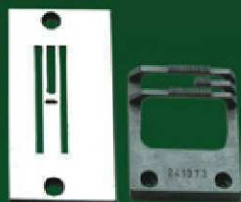

JZ-12521
241372 / 241373

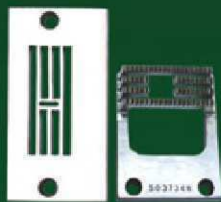

JZ-12522
503733N / 503734N

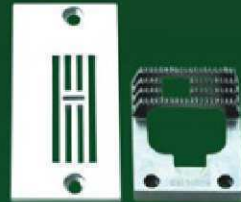

JZ-12523
22581409/22581508

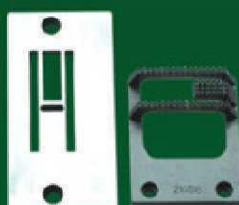

JZ-12524
210600 / 210518

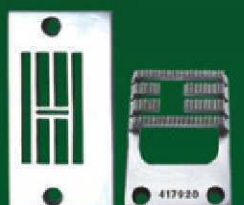

JZ-12525
282188 / 417920

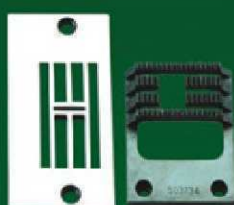

JZ-12526
503733 / 503734

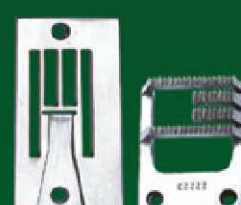

JZ-12527
22185 / 22223

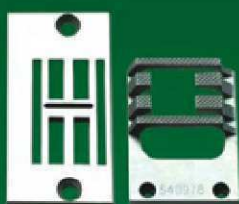

JZ-12528
543977 / 543978

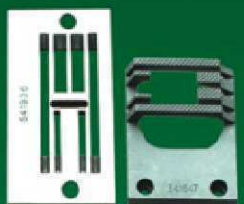

JZ-12529
541936 / 541647

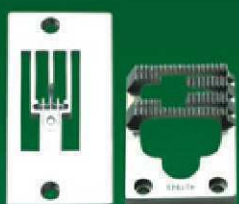

JZ-12530
22186/417921

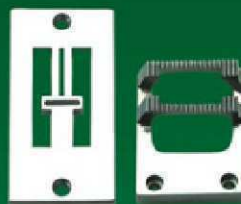

JZ-12531
200905/200906

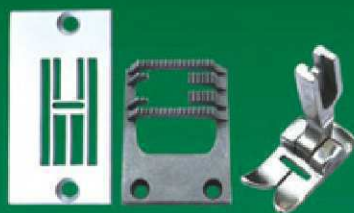

JZ-12532
20U 6mm GAUGE SET

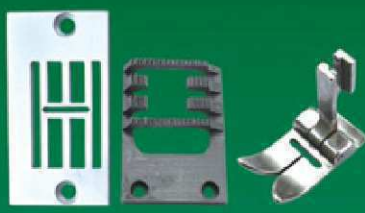

JZ-12533
20U 12mm GAUGE SET



JZ-12534
2106008 GAUGE SET



JZ-12535
平车切边器GUNTING GAUGE SET



JZ-12536
喇叭厚料针板、牙



JZ-12537
兄弟B型针板、牙



JZ-12538
34245针板、牙



JZ-12601
16303



JZ-12602
12481 (9T-22T)



JZ-12603
44种 (9T-17T)



JZ-12604
A10



JZ-12605
B1613-522-W00



JZ-12606
12481 斜牙



JZ-12607
B1613-522-N00



JZ-12608
213



JZ-12609
K10



JZ-12610
149319



JZ-12611
12481 特细牙



JZ-12612
26603



JZ-12613
12369



JZ-12614
12436



JZ-12615
96



JZ-12616
150793W



JZ-12617
B1613-4500-000



JZ-12618
149057 斜牙



JZ-12619
18031B



JZ-12620
150793B



JZ-12621



JZ-12622
272153



JZ-12623
111860



JZ-12624
149057 特细牙



JZ-12625
A70



JZ-12626
149057



JZ-12627
18031



JZ-12628
B1613-555H-000



JZ-12629
12481R



JZ-12630
12481TR



JZ-12631
124812R



JZ-12632
149057R



JZ-12633
149057TR



JZ-12634
B1609-415-H0B



JZ-12635
B1609-041-F00



JZ-12636
T530



JZ-12637
210518



JZ-12638
210523



JZ-12639
210516A4



JZ-12640
652/12M



JZ-12641
652/5M



JZ-12642
543978D



JZ-12643
543978



JZ-12644
541647D



JZ-12645
541647



JZ-12646
241373



JZ-12647
417920S

JINZEN PRODUCT BEAMED MAGNIFICENCE

金振产品 神采飞扬



JZ-12648
FR313



JZ-12649
12481 菠萝牙



JZ-12650
144500



JZ-12651
12481D 菠萝牙



JZ-12652
FR209



JZ-12653
FR213



JZ-12654
APS-12 防皱牙



JZ-12655



JZ-12656
99601



JZ-12657
211105-223B



JZ-12658
FD6051-0A



JZ-12659
D711 高林



JZ-12660
52031



JZ-12661
B1613-111-000



JZ-12662
B1613-111-A00



JZ-12663



JZ-12664
272153 菠萝牙



JZ-12665



JZ-12666
806012 粗



JZ-12667
806012



JZ-12668
147327



JZ-12669
1613012T



JZ-12670
149165



JZ-12671
方德电脑平车



JZ-12672
842



JZ-12673
3168



JZ-12674
家用牡丹牙



JZ-12675
R28



JZ-12676
532098/307



JZ-12677
445789



JZ-12678
GB4-1



JZ-12679
GA5-1



JZ-12680
531667



JZ-12681
153286



JZ-12682
811



JZ-12683



JZ-12684
210524



JZ-12685
503286



JZ-12686
502547



JZ-12687
503743



JZ-12688
210524



JZ-12689
417919S



HI258/DI206



HI262/DI216



257242/257289



208217/208064



204676/208078-BF



210442/210569



H445/D575



DF-8040T/82107



DF-85407/FD830



HI259/DI207



257259/257207



Y3109020 Y310902I



208215/208063



204676/208079-BF



210494/210581



H494/D581



BI657-814-80E/9710I



I21735/B3006



257262/257216



DFF00560/FDF00560



257243/257290



208219/208066



I46748/I46744



210501/210582



H442/D290



DF-86504/FD824



I18-85407/83006



HI261/DI215



3209001/3209000

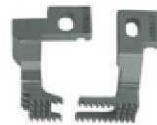

3109000/310900I



I46572/I46567



H445/D574



H501/D582



210497/210581



I18-86504/82404



I21-73308/84004



257258/257206



257290/257243



DFC00560/FDC00560



210445/210575



204732
204675 204674



H497/D581



204730/208090-BF



DF-BI4BE/FD971



I18-85209/82800



3209002/3209003



I5-8060/I5-8050



H4258/D4206



204675A 204676



H974/D969



H500/D581



BI657-804-00T/82107



I18-86009/84004



I21-72805/82800



DL4



IS-704



FE15

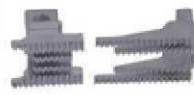

FD-62G 双切牙子



FD-62G 单切牙子



IS-760



3159034/3159037



34726F/34705F

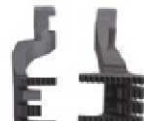

H1359/D1207



3209012/3209013



祖奇241牙



B1657-816-000
B1656-816/B1658-804



3509036/3509037

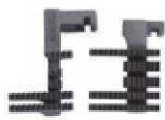

Y3509036/Y3509037



FE40/FE16-Z/FE41



Y93394/Y93395



3209008/3209009



257268-16F/257222-16F



3109002/3109003



3509004/3509005



IS-753/IS-723



IS-756/IS-727



关西四行牙



90624/90625



Y34852/34851



21842/21846



6509012
6509002
6509022



H3362/D3216



IS-36/IS-301



50326AY/503058A



146750/146745



四线打皱牙



202854A/201094B



201097C/201094B



B1657-814-B0L
B1656-814-B0A
B1658-804



B1657-814-B0A
B1656-814-B0A
B1658-804



277327-16F
277329-16F



Y2109050/Y2109051



277323/277325



H497/D498



Y2108050/Y2108051



Y2109000/Y2109001



S20245/S20241



S19240-001
S19212-001



H959/D996



H957/D002



277304-16F
277305-16F



277300-16F
277302-16F



208224/208063



208215/208063



208218/208065



213118-16F0



204420/208074



118-85902
118-84103/87403

JUKI



118-88005-80#



118-88104-81#



118-88203-82#



118-88302-83#



119-99208-92#



121-76004-60#



121-76103-61#



124-81008-10#



124-81107-11#



B2519-804



B2519-814



B2521-814



B2521-804



119-99307



118-88401



119-99802



124-81800



B2009-038-D00 3/16#



B2009-038-K00 3/8#



B2008-038-D00 3/16#



B2008-038-K00 3/8#



MH481
B2030-481-000



MH380
B2031-380-000



MS1190
129-69101



MS1190
129-79209



MS1190
129-79308



MS1190
129-68509



MS1190
129-68806



MS1190
129-68868



MS1190
129-68905



1/4#
B2513-026-F00
MS-26



1/4#
B2514-026-000
MS-26



A1/8
B2513-019-B00
MS-19



B1/8
B2514-019-B00
MS-19



1/4#
B2514-019-F00
MS-19



1/4#
B2515-026-F00
MS-26



1/4#
B2513-019-F00
MS-19



118-90605



118-90001



124-84002



121-77903



121-20705



128-29405



118-90100



124-84507



120-15301



118-90506

HIGH QUALITY LOOPER



118-90704



35825



B1239-372



B1239-373



124-82600



118-29405

brother



146962



147934



144042



147936



147937



S20430001



S20438001



S20424001



146613-001



148875



S03536-001



S40375-001
B928



148869
B926-6A



148870
B926-6A



148871
B926-6A



S40376-001
B928



S40377-001
B928



S08913



S40391-001 3/16B
B927



111156-001 1/4C



S40392 3/16A
B927



111160-001 1/4B



111162-001 1/4A



S20627-001



S20626-001



S20653-001



144049-001



S01249-001



S01248-001



146726-001



144127



S20418



146635-001



B3901-880-A00



2200



HIGH QUALITY LOOPER



277061



277004



209009



210275



277007



209668



277000



277006



277005B



277005A



277005



277008



236500



206097A



257555



257550



257551



236610



257566

KANSAI
METAL



19-416



19-581



19-582



19-582



19-811



19-112



19-431A 2.5mm



19-431S 2.3mm



19-431 3.2mm



19-431N 2.7mm



19-512



19-531



19-353



19-362



19-518



19-535



19-801



19-363



19-351



19-539



19-713



19-810



19-536



19-712



19-807



19-505



19-751



19-437



19-525

Ijamato



32807



2109201



302056



32416



34392



6209300



36228



2109214



90529



2109300



90425



6209302



34584



6509300



94480



2109347



3209300



6209304



33610



68217



3209311



35253



3109310



2109320



3109200



Y68124



63178



35254



93659



2109322



68123



3109300



6209301



34393



31261

Kingtex



LL603884



51108DA



UL603883-83#



LL603885



51909C



UL603882-82#



CL605294



33808AY(AU)



UL603880-80#

UNION
于仁



35809AY(AV)



UL603881-81#



51809



35809AY(AY)



51808



54208B

HIGH QUALITY LOOPER

SINGER



139056 1/4C



139434 3/16B



32822



139433 3/16A



550411



32820



139433 1/4A



550568



32823



139057 1/4B



543232



32821



139288 1/4A



548231

548205



32824



139434 1/4B



548207

SIRUBA



LP22



HE22



ME28



KL202



KG37



LP26



LP26A



HE21



ME28A



KL25A



MH41



LP225



LP21



MU10



KG59



KL25



KM04



LP226



LP23



MT01



KG37直



KL35



KM04A



LP227



LP38



MT01A



KG31



KL65



ME67



LP24



MU06



VE51



KG79



ME67

OTHER



400041



77013



36-19



36-21



175085



GJ4-2



CP161



31278L



FE22-1



FE22



GK73-2-401



033122



FD11



对丝机零件
JZ-PO65-1

JZ-PO65-2

利士



104C 104B 104A 104D

杜克普



557002872 557000611 558002035 558000602A



重机JUKI 3200 LOOPER



杜克普DURKOPP557 LOOPER



杜克普DURKOPP558 LOOPER



兄弟BROTHER980 LOOPER



利士REECE101 LOOPER



利士REECE104 LOOPER

Kingtex 宝狮

SENBEN 森本



NC605048
JZ-12801



NC604026
JZ-12802



NC604022
JZ-12803



NCC00561
JZ-12804



NCC00641
JZ-12805



I2-828
JZ-12806



I2-807
JZ-12807



I2-826
JZ-12808



I2-839
JZ-12809



I2-828
JZ-12810



I2-229
JZ-12811



I2-819
JZ-12812



I2-818
JZ-12813



I2-812
JZ-12814



I2-811
JZ-12815



I2-813
JZ-12816



I2-802
JZ-12817



I2-801
JZ-12818



810 1/16
JZ-12819



810 3/32
JZ-12820



8810 2.4
JZ-12821



380 1/8
JZ-12822



925 1/4
JZ-12823



MS19 1/4
JZ-12824



8-1 1/4
JZ-12825



515 1/4
JZ-12826



1190 1/4
JZ-12827



926-8A
JZ-12828



MS26
JZ-12829



926
JZ-12830



1162 1/4
JZ-12831



20202 1/8
JZ-12832



845 1/8
JZ-12833



3168 9/16
JZ-12834



手跳3/16针头
JZ-12835



手跳1/2针夹
JZ-12836



35800
JZ-12837



35800
JZ-12838



35800
JZ-12839



928
JZ-12840



928
JZ-12841



928
JZ-12842



1190
JZ-12843



1190
JZ-12844



MS19
JZ-12845



MS19
JZ-12846



925
JZ-12847



1261
JZ-12848

OUR QUALITY, YOUR TRUST

Yamato 大和



2159102



2109232



2109120



2109122



2159111



2159112



2109100



2109102



2109101



2109112



2109110



Y3209100



Y3209102



Y3209107



3209101



Y3209108



Y93351



3209107



3109111



3109112



Y93356



Y93358



Y93352



3109111



Y93353



Y93357



Y93358

PEGASUS 飞马



209670



208905



208914



208909



208910



179630-92



277022-92



277028-92



277027-92



277031-92



208965



257517-40



257517-48



257518-64



257518-48



257517-56



257518-60



257517-32



257518-56



257513-460



236631-56



257517-64



257517-28

SHING LING

星菱



FC356



FC364



FC348



FC240



35818BY9

brother
兄弟



S20398-001



S15711/S15722-001



S15783/S15784-001



S08713-001



S20406-001



S15717/S15718-001



S15783/S15784-001



S08709-001



S20404-001



S15765/S15766-001



S15795/S15796-001



S08711-001



I46775-001 I46773-001



S15747/S15748-001



I58794-I-01



I46491-001 I46489-001



S15771/S15772-001



I58796-I-01



S15723/S15724-001



S32122/S32123-001



I181716-001

JUKI
重机



I24-65100



I21-50306



I18-70359



BI402-528-CAL/CAR



BI402-528-LAL/LAR



I21-49803



I21-48607 I18-69005 铁



I21-50306 铁



BI402-528-GAL/GAR



BI402-525-IAL/IAR



I21-48706



I18-69658 铁



I18-70458 铁



BI402-528-HAL/HAR



BI402-528-MAL/MAR



BI420-714-800



I24-65001 I24-65100 铁



I18-70854



BI402-528-KAL/KAR



BI409-809-GAO



BI420-716-F00



BI420-716-D00



I21-50603



BI402-528-EAL/EAR



BI409-809-HAO

SIRUBA
银箭



KG131 KG142



M4348



KG153



M4460



KG333



M4356



KG355



M4232



M4240



M4248



M4364

因为用心，所以专业
BECAUSE THE HEART, SO PROFESSIONAL

PRESSER FOOT



S-P975 4线
JZ-13501



S-P975 3线
JZ-13502



Y-2107031 3线
JZ-13503



Y-2157115 4线
JZ-13504



Y-2107301 3线
JZ-13505



2107302 飞马小压脚
JZ-13506



Y-2157116 4线带槽
JZ-13507



P-201230C-4线
JZ-13508



P-208730 4线带槽
JZ-13509



P-201230C 3线卷边
JZ-13510



737/302 3线卷边
JZ-13511



J124-66553
JZ-13512



P253E/F374
JZ-13513



205253
JZ-13514



F371/P253E 特细
JZ-13515



124-66058
JZ-13516



747 压脚
JZ-13517



P101/F371 3线拉带
JZ-13518



Ex277122
JZ-13519



EX277119
JZ-13520



201152E/277115
JZ-13521



Ex2119870 3线
JZ-13522



EX277111 4线带槽
JZ-13523



Ex277112 44线
JZ-13524



118-79251
JZ-13525



118-81455
JZ-13526



118-81554
JZ-13527



277118
JZ-13528



EX277125 44线打摺
JZ-13529



2516 3针6线
JZ-13530



118-77766 厚料
JZ-13531



118-77552 薄料
JZ-13532



118-76059/76067
JZ-13533



YAMATO 4线
JZ-13534



P233 SIRUBA 3N/6T
JZ-13535



P508
JZ-13536

PRESSER FOOT



PEGASUS 4线
JZ-13537



747 4线
JZ-13538



JZ-13539



JZ-13540



JZ-13541



JZ-13542



JZ-13543



JZ-13544



JZ-13545



257321-56
JZ-13546



257321-64
JZ-13547



JZ-13548



208649
JZ-13549



208502
JZ-13550



P502中厚料
JZ-13551



3316 5线
JZ-13552



208504
JZ-13553



P504
JZ-13554



P233
JZ-13555



P509
JZ-13556



M0816
JZ-13557



P955
JZ-13558



208955
JZ-13559



P005银箭包兜
JZ-13560



257471-56
JZ-13561



257472-64
JZ-13562



W500压脚
JZ-13563



W500滚珠压脚
JZ-13564



257472-56
JZ-13565



P0217
JZ-13566



17-836
JZ-13567



S08826
JZ-13568



W500 4针六线
JZ-13569



257461-56
JZ-13570



257485
JZ-13571



GK31010
JZ-13572



YAMATO
JZ-13573



17-8850-1
JZ-13574



208952 / 208108
JZ-13575



119-32456/36804
JZ-13576



123-30007 / 20057
JZ-13577



YAMATO
JZ-13578



17-301
JZ-13579



S19260-001
JZ-13580



201230C
JZ-13581



S19280-001
JZ-13582



146902-001
JZ-13583



圆线打皱压脚
JZ-13584



2200R 5.6MM
JZ-13585



Y95587 5.6MM
JZ-13586



257240 5.6MM
JZ-13587



VG2700 5.6MM
JZ-13588



JH004-053A 5.6MM
JZ-13589



94909 5.6MM
JZ-13590



Y3117124 VG3711
JZ-13591



Y3507064 VG3721
JZ-13592



Y95316 5.6MM
JZ-13593



17-760
JZ-13594



17-361
JZ-13595



17-889
JZ-13596



211909
JZ-13597



S19313-201
JZ-13598



124-70258
JZ-13599



2117035
JZ-13600



五线打皱压脚
JZ-13601



212887A
JZ-13602



257331A56
JZ-13603



148013-001
JZ-13604



146871
JZ-13605



五线窄压脚
JZ-13606



PF634D03
JZ-13607



圆线打皱压脚
JZ-13608



32760
JZ-13609



32750
JZ-13610



33539
JZ-13611



2117024
JZ-13612



四针六线压脚
JZ-13613



B1510-352-0A0
JZ-13614



B1510-357-AA0
JZ-13615



B1507-816-0A0
JZ-13616



B1507-814-0A0
JZ-13617



FD356
JZ-13618



P2408
JZ-13619



P103-4
JZ-13620



747肩带
JZ-13621



205136
JZ-13622



17-899
JZ-13623



JZ-13701
 CL1/32N
 CL1/16N
 CL3/32N
 CL1/8N
 CL5/32N
 CL3/16N
 CL1/4N
 CL5/16N
 CL3/8N
 CL1/2N



JZ-13702
 CR1/32N
 CR1/16N
 CR3/32N
 CR1/8N
 CR5/32N
 CR3/16N
 CR1/4N
 CR5/16N
 CR3/8N
 CR1/2N



JZ-13703
 CL1/32E
 CL1/16E
 CL3/32E
 CL1/8E
 CL5/32E
 CL3/16E
 CL1/4E
 CL5/16E
 CL3/8E
 CL1/2E



JZ-13704
 CR1/32E
 CR1/16E
 CR3/32E
 CR1/8E
 CR5/32E
 CR3/16E
 CR1/4E
 CR5/16E
 CR3/8E
 CR1/2E



JZ-13705
 CLK
 CL1/32K
 CL1/16K
 CL3/32K
 CL1/8K
 CL5/32K
 CL3/16K
 CL1/4K
 CL5/16K
 CL3/8K
 CL1/2K



JZ-13706
 CRK
 CR1/32K
 CR1/16K
 CR3/32K
 CR1/8K
 CR5/32K
 CR3/16K
 CR1/4K
 CR5/16K
 CR3/8K
 CR1/2K



JZ-13707
 12463HR
 1/32 (P810)
 1/16 (P811)
 3/32 (P8115)
 1/8 (P812)
 3/16 (P813)
 1/4 (P814)
 5/16 (P815)
 3/8 (P816)
 1/2 (P818)



JZ-13708
 12463HL
 1/32 (P810L)
 1/16 (P811L)
 3/32 (P8115L)
 1/8 (P812L)
 3/16 (P813L)
 1/4 (P814L)
 5/16 (P815L)
 3/8 (P816L)
 1/2 (P818L)



JZ-13709
 36069HL
 P69LH-1/16
 P69LH-1/8
 P69LH-3/16
 P69LH-1/4
 P69LH-5/16



JZ-13710
 36069HR
 P69RH-1/16
 P69RH-1/8
 P69RH-3/16
 P69RH-1/4
 P69RH-5/16



JZ-13711
 SP-18L
 SP-18L 1/16
 SP-18L 1/8
 SP-18L 3/16
 SP-18L 1/4



JZ-13712
 SP-18R
 SP-18R 1/16
 SP-18R 1/8
 SP-18R 3/16
 SP-18R 1/4



JZ-13713
 LOT NO.
 160344 1/16 (NO.1)
 120938 3/32 (NO.2)
 120805 1/8 (NO.2-1/2)
 120804 5/32 (NO.3)
 120805 3/16 (NO.4)
 120940 7/32 (NO.5)
 120806 1/4 (NO.6)
 120803 5/16 (NO.7-1/2)



JZ-13714
 A10 PRESSER FOOT
 A10-5/8
 A10-3/4
 A10-7/8
 A10-1
 A10-1-1/8
 A10-1-1/4
 A10-1-1/2
 A10-1-3/4



JZ-13715
 36465
 P10-1/32
 P11-1/16
 P115-3/32
 P12-1/8
 P13-3/16
 P14-1/4
 P15-5/16
 P16-3/8
 P18-1/2



JZ-13716
 CD
 CDN-1/32(D23N)
 CD-1/32(D23)
 CDN-1/16(D231N)
 CD-1/16(D231)
 CD-1/8(D232)
 CD-3/16(D233)
 CD-1/4(D234)



JZ-13717
 211-15
 211-13(1/16×3/16)
 211-14(1/16×1/4)
 211-15(1/16×5/16)
 211-16(1/16×3/8)
 211-18(1/16×1/2)



JZ-13718
 S10R
 P318R-1/8
 P3316R-3/16
 P314R-1/4
 P3516R-5/16
 P338R-3/8
 P3716R-7/16
 P312R-1/2
 P358R-5/8
 P334R-3/4
 P378R-7/8
 P325R-1



JZ-13719
 S570R (P112H)
 1/8×1/32
 3/16×1/32
 1/4×1/32
 5/16×1/32
 3/8×1/32
 1/2×1/32
 5/8×1/32
 3/4×1/32
 7/8×1/32
 1"×1/32



JZ-13720
 S570L (P112L)
 1/8×1/32
 3/16×1/32
 1/4×1/32
 5/16×1/32
 3/8×1/32
 1/2×1/32
 5/8×1/32
 3/4×1/32
 7/8×1/32
 1"×1/32



JZ-13721
 S570DG (P112HD)
 3/16×1/32
 1/4×1/32
 5/16×1/32
 3/8×1/32
 7/16×1/32
 1/2×1/32
 9/16×1/32
 5/8×1/32
 11/16×1/32
 3/4×1/32
 7/8×1/32
 1"×1/32



JZ-13722
 S570 (P112H)
 1/8×1/16
 3/16×1/16
 1/4×1/16
 5/16×1/16
 3/8×1/16
 1/2×1/16
 5/8×1/16
 3/4×1/16
 7/8×1/16
 1"×1/16



JZ-13723
 S570L (P112HL)
 1/8×1/16
 3/16×1/16
 1/4×1/16
 5/16×1/16
 3/8×1/16
 1/2×1/16
 5/8×1/16
 3/4×1/16
 7/8×1/16
 1"×1/16



JZ-13724
 S570DG (P112HD)
 3/16×1/16
 1/4×1/16
 5/16×1/16
 3/8×1/16
 7/16×1/16
 1/2×1/16
 9/16×1/16
 5/8×1/16
 11/16×1/16
 3/4×1/16
 7/8×1/16
 1"×1/16

**WHOLE STEEL
PRESSER FOOT 全钢压脚**

JINZEN®



JZ-13725
P36LN



JZ-13726
P36N



JZ-13727
P363



JZ-13728
12435N



JZ-13729
31358N



JZ-13730
12435W



JZ-13731
121946



JZ-13732
P351



JZ-13733
24983



JZ-13734
P360



JZ-13735
P363NF



JZ-13736
P127



JZ-13737
B1524-012-080



JZ-13738
B1524-522-80A



JZ-13739
B1524-522-NAA



JZ-13740
CR1/16NS



JZ-13741
P952



JZ-13742
150789



JZ-13743
S518S



JZ-13744
S518NS



JZ-13745
P31C 3/16



JZ-13746
A-10 3/4



JZ-13747
A-10 1-1/4



JZ-13748
NL-31S



JZ-13749
36069L



JZ-13750
36069DG



JZ-13751
36069R



JZ-13752
P50N



JZ-13753
P5



JZ-13754
36069L 3/8



JZ-13755
P3819



JZ-13756
S540



JZ-13757
S538



JZ-13758
CF351



JZ-13759
RF1/32N



JZ-13760
LF1/4

WHOLE STEEL PRESSER FOOT 全钢压脚



411215
胜家人字靴-TH



10055051
祖奇人字压脚



22848671



MAB109000B0
祖奇胸罩靴



SA1231-9A 压脚



457G 13MM
胜家人字靴



107L 管正靴-大



23771 正靴弹丝



107C 管正靴销钉-小



107C 管正靴弹-小



503818
胜家人字靴-TH



23207 人字车压脚



457G-KC-TS-02
人字靴开叉-弹丝-中



457G-PK-01
人字靴-平口-大



457G-PK-01
人字靴-平口-大



457G-PK-TS-01
人字靴-平口-弹丝大



457G-PK-TS-02
平口弹丝-中



457G-WC-01
人字靴-无槽-大



457G-WC-02
人字靴-无槽-中



457G-WC-TS-01
人字靴-无槽-弹丝-大



457G-WC-TS-02
人字靴-无槽-弹丝-中



457 1/4 X1/32L
带刀靴



457 1/4 X1/32R
带刀靴



210569 胜家人字靴



457G-KC-01
人字靴-开叉-大



457G-KC-02
人字靴-开叉-中



457 3*16X1/32R
带刀靴



457G-KC-TS-01
人字靴-开叉-弹丝-大



005-1-4A
胸罩车靴



212-005A
可调节捆条压脚



005-1/8A 胸罩车靴



457-AL
胸罩车平底靴-大



457-A
胸罩车平底靴-小



457-A
胸罩车平底靴-2弹-小



457-AL 胸罩车
平底靴-弹丝-大毫



R23771 滚轮压脚



21010-1L
6.4MM1/4S



21010-1R
6.4MM1/4S



21010-1L
6.4MM1/4W



21010-1R
6.4MM1/4W



212-112
1/4中带刀靴



457G-friend
梯型人字靴



双针打带压脚1/4



双针打带压脚
(全开槽) 1/4



23073 6.4MM
双针打带靴 (新款)



S2ZM3/8
双针制帽压脚3/8



双针打拆压脚
1/4D/N



107C-4L (4L)
胜家人字靴



210569A
胜家人字靴



210569A



平车滚轮靴
F型



平车滚轮靴
(新型)



R2E滚轮压脚



1005505 JUKI
人字车压脚



22548671 JUKI
人字车压脚



22548655 JUKI
人字车压脚



503736
人字靴 (新型)



457GB (23766A)
胸罩靴



210562A4



S950 (P950)
缩皱压脚



R2滚轮压脚



双针大孔压脚



P803



S537 1/4



棉花压脚



P723



652 8MM压脚



652 12MM压脚



P127L



5538105三菱双针压脚



DY340带刀压脚小号



L52-A型打折靴

PRESSER FOOT



JZ-14101
S380WORK FOOT



JZ-14102
240570/240568TEETH



JZ-14103
S380AWORKFOOT



JZ-14104
JK247P/FSJK247



JZ-14105
S380B WORKFOOT



JZ-14106
240570/240568



JZ-14107
U67T压脚



JZ-14108
U-30/U-31



JZ-14109
U-30W/U-31W3/16A



JZ-14110
8B O/F R 8B外脚 右



JZ-14111
8B O/F R 8B外脚 左



JZ-14112
EJ1235-0A 4150外脚



JZ-14113
10795/10796 8B



JZ-14114
S380B PIPING 5MM



JZ-14115
240148/240149 8B



JZ-14116
241NJ 内脚



JZ-14117
S009 压脚



JZ-14118
S380B PIPING3MM



JZ-14119
AS-005893-00压脚



JZ-14120
GP-000203-00
GP-000204-00



JZ-14121
05-002A-106L
15-070A-106L



JZ-14122
S380A PIPING 3MM



JZ-14123
U192Y/U193Y-A



JZ-14124
NM-330 DY330新型



JZ-14125
10795K/10796K
3/16B



JZ-14126
10795K/10796K



JZ-14127
U192T/U193T



JZ-14128
601-3/601-2R 1/8



JZ-14129
601-3/5218W



JZ-14130
U192-2/U193-2



JZ-14131
DY320



JZ-14132
WK-330 DY330 小号



JZ-14133
10795K/10796K
3/16A



JZ-14134
91-049585-04
91-049269-04



JZ-14135
91-040432-04
91-040629-04



JZ-14136
91-014522293



JZ-14137
DY320
91-14922293 压脚



JZ-14138
8B P-F 3.0MM



JZ-14139
20795, 20796
有齿、同步压脚



JZ-14140
DY340 A型 3.5MM



JZ-14141
DY340 B型 3.5MM



JZ-14142
高车棉绳压脚 8#



JZ-14201
Br Presser foot 2.4mm(M)



JZ-14202
Br Presser foot 3mm(L)



JZ-14203
Br Presser foot 2.0mm(S)



JZ-14204
Br Presser foot 3mm(L)



JZ-14205
Br Presser foot 2.4mm(M)



JZ-14206
Br Presser foot 2.0mm(S)



JZ-14207
35830BX-9 35800



JZ-14208
10712909/10711802



JZ-14209
341YJ3MM



JZ-14210



JZ-14211



JZ-14212



JZ-14213



JZ-14214



JZ-14215



JZ-14216



JZ-14217



JZ-14218



JZ-14219



JZ-14220 JZ-14221



JZ-14222



JZ-14223



JZ-14224 JZ-14225



JZ-14226



JZ-14227



JZ-14228



JZ-14229



JZ-14230



JZ-14231



JZ-14232



JZ-14233



JZ-14234



JZ-14235



JZ-14236



JZ-14237



JZ-14238



T350 T350B
JZ-14301



T652 12MM T652B 12MM
JZ-14305

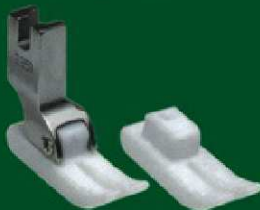

T351 T351B
JZ-14309



MT-260 3/16, 1/4, 2/16,
3/8, 1/2, 3/4, 1#
JZ-14313



T35CW 11MM, 12.5MM, 15MM
JZ-14317



MT-18 MT-18B
JZ-14321



T363 T363B
JZ-14302



T652 9MM T652B 9MM
JZ-14306



T351 T351B 11MM
JZ-14310



MT-260 1/8 MT-1/8 B
JZ-14314



T69R 1/8, 1/4, 3/16 T69RB
JZ-14318



T350L T350LB
JZ-14322



T36LN T36LNB
JZ-14303



T652 6MM T652B 6MM
JZ-14307



T35W 12.5MM
T35WB
JZ-14311



MT-A MT-AB 12.5MM
JZ-14315



T69L 1/8, 1/4, 3/16 T69LB
JZ-14319



T-107 T-107B
12MM, 9MM, 6MM
JZ-14323



T36N T36NB
JZ-14304



T36L T36LN
JZ-14308



MT1 MT2
JZ-14312



528T-5.6 528TB
JZ-14316



T-S518 T-S518B
JZ-14320



T-S518 YKK
JZ-14324

TEFLON PRESSER FOOT 铁氟龙压脚



SPK6
JZ-14325



飞马五线薄料
JZ-14326



飞马五线厚料
JZ-14327



飞马四线
JZ-14328



银箭四线
JZ-14329



MF23-7 MF23-7B
JZ-14330

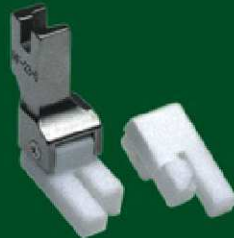

MF23-8 MF23-8B
JZ-14331



T350D T350DB
JZ-14332



T350L T350LB
JZ-14333



T813 T813B
JZ-14334



T812 T812B
JZ-14335



T811 T811B
JZ-14336



T815 T815B
JZ-14337

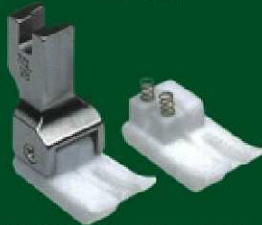

TCL1/32, 1/16, 1/8, 1/4, 1/2
JZ-14338

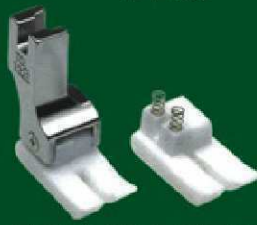

TCL1/32E, 1/16E, 1/8E, 1/4E
JZ-14339



TCR1/32, 1/16, 1/8, 1/4, 1/2
JZ-14340



TCR1/32E, 1/16E, 1/8E, 1/4E
JZ-14341



T814 T814B
JZ-14342



SR-DB-R SR-DB-RB
JZ-14343



TRF1-R
JZ-14344



5mm 8mm 10mm
12mm 15mm 20mm
JZ-14345



T8115SR T8115SRB
JZ-14346



T812SR T812SRB
JZ-14347

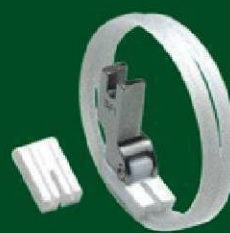

TRF1 TRF1B
JZ-14348



T811SR T811SRB
JZ-14349



JZ-15001
8700



JZ-15002
BR201



JZ-15003
20U



JZ-15004
BR735



JZ-15005
GC6-1



JZ-15006
JUK18700



JZ-15007
8700



JZ-15008
5550



JZ-15009
BR735



JZ-15010
555



JZ-15011
SUNSTAR



JZ-15012
GC6-1



JZ-15013 335



JZ-15014 BR831



JZ-15015 820



JZ-15016 罗拉车(自动纺线)



JZ-15017 8810



JZ-15018 8820



JZ-15019 12N



JZ-15020 F007



JZ-15021 8N



JZ-15022 W500



JZ-15023 关西



JZ-15024 928



JZ-15025 24N



JZ-15026 845新款

灌注東方文化 提煉永久品質
鑄就金振品牌 服務全球客戶



JZ-15027
M600



JZ-15028
1404



JZ-15029
6-1 新款



JZ-15030
457



JZ-15031
SINGER



JZ-15032
海凌



JZ-15033
1900A



JZ-15034
781



JZ-15035
781



JZ-15036
1850



JZ-15037
关西



JZ-15038
标准



JZ-15039
515



JZ-15040
88双针



JZ-15041
88单针



JZ-15042
海凌(A)



JZ-15043
海凌(B)



JZ-15044
842



JZ-15045
845-A



JZ-15046
845-B



JZ-15047
3168



JZ-15048
3128



JZ-15049
1162



JZ-15050 1508



JZ-15051 1404



JZ-15052 C007(A)



JZ-15053 VC008



JZ-15054 C007(B)



JZ-15055 标准



JZ-15201



JZ-15202



JZ-15203



JZ-15204



JZ-15205



JZ-15206



JZ-15207



JZ-15208



JZ-15209



JZ-15210



JZ-15211



JZ-15212



JZ-15213



JZ-15214



JZ-15215



JZ-15216



JZ-15217



JZ-15218



JZ-15219



JZ-15220

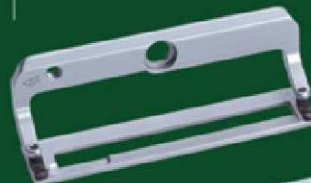

JZ-15221



JZ-15222

Rubbe胶底 Rsteel铁齿

B1511-771-0A0 B1511-761-0A0
 B1511-772-0A0 B1511-762-0A0
 B1511-773-0A0 B1511-763-0A0

Rubbe胶底 Rsteel铁齿

150763-001 16mm
 150764-001 25mm
 150766-001 32mm



JZ-15301
日星



JZ-15302
日星



JZ-15303
日星



JZ-15304
日星



JZ-15305
日星



JZ-15306
日星



JZ-15307
重机 8800



JZ-15308
重机 1900(大)



JZ-15309
兄弟 7200



JZ-15310
重机 9000A



JZ-15311
重机 9000



JZ-15312
重机 1900(小)



JZ-15313
重机 522



JZ-15314
重机 1903



JZ-15315
胜家 457



JZ-15316
标准 6180



A9 打褶器
JZ-15409



G900E 打褶器
JZ-15410



平车切刀组 SC-735
JZ-15414



SIRUBA 五线打褶器
JZ-15415



JUKI 四线打褶器
JZ-15416



JUKI 五线打褶器
JZ-15417



SIRUBA 四线打褶器
JZ-15412



PEGASUS 五线打褶器
JZ-15413



JZ-15436 36900



JZ-15437 L32



JZ-15438 兄弟



JZ-15439 M700



PEGASUS L52
JZ-15401



PEGASUS M600
JZ-15402



PEGASUS M700
JZ-15403



KINGTEX SH7000-4
JZ-15404



KINGTEX SH7000-5
JZ-15405



SIRUBA 747
JZ-15406



SIRUBA 747 卷边器
JZ-15407



SIRUBA 757
JZ-15408



JZ-15418
PG L52--A型 打折压脚



JZ-15419 380 定规



JZ-15420
CW-8B GB-6 新款820定规



JZ-15421 平缝定规



JZ-15422 820D 定规



JZ-15423
AS-005993-00 定规



JZ-15424 340定规



JZ-15425
CW-8B GB-2 精工8B定规



JZ-15426 380B 定规



JZ-15435 810 定规



GB-1 吊磅
JZ-15411

JINZEN®



JZ-15440
747辅助装置



JZ-15470



JZ-15427



JZ-15428



JZ-15429



JZ-15430



JZ-15431



JZ-15432



JZ-15433



JZ-15434



JZ-15501 A10/S60 平车直角包边筒
Right Angle Bias Binder

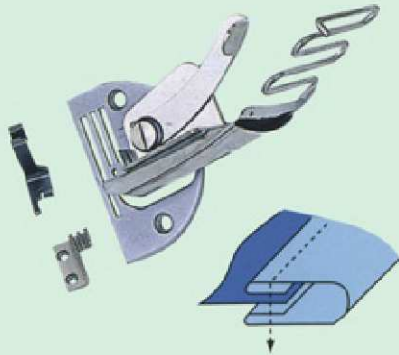

入口
16mm
18mm
20mm
22mm
24mm
26mm
28mm
30mm
32mm
34mm
36mm
38mm
40mm
45mm
50mm

作用: 细弯布边
用机: 单针平车
Purpose: Binding of curve edge
Machine: 1 Needle Lockstitch Machine

标准厚度: M MH

JZ-15502 S64 (F531) 平车直角包边筒 (散口)
Right Angle Bias Binder

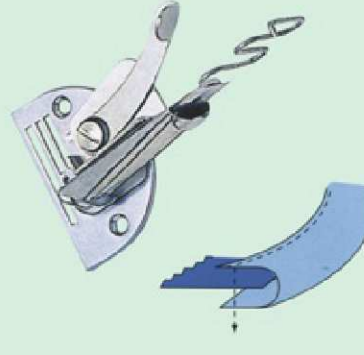

入口
12mm
14mm
15mm
16mm
18mm
20mm
22mm
24mm
25mm
26mm
28mm
30mm
32mm

作用: 细弯布边
用机: 单针平车
Purpose: Binding of curve edge
Machine: 1 Needle Lockstitch Machine

标准厚度: M MH

JZ-15503 A11/S72L 拉脚筒
Swing Hemmer

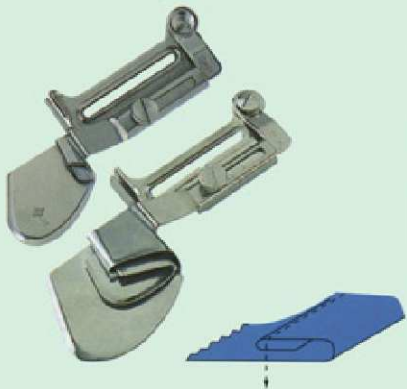

规格	
1/8"	1-1/8"
3/16"	1-3/16"
1/4"	1-1/4"
5/16"	1-3/8"
3/8"	1-1/2"
7/16"	1-5/8"
1/2"	1-3/4"
9/16"	1-7/8"
5/8"	2"
11/16"	
3/4"	
13/16"	
7/8"	
1"	

作用: 一般直折边用
用机: 单针平车
Purpose: General straight hemming
Machine: 1 Needle Lochstitch Machine

标准厚度: M MH H

JZ-15504 A70/S70 摆动式弹弓嘴卷边器
Spring Type Swing Hemmer

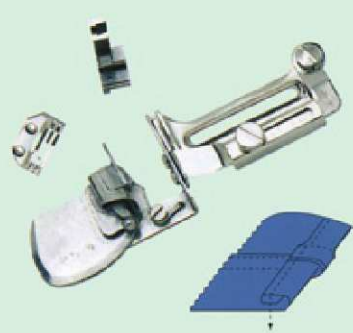

规格
1/8"
3/16"
1/4"
5/16"
3/8"
1/2"
5/8"

作用: 折边用, 筒嘴有弹性, 能容许厚骨通过
用机: 单针平车
Purpose: General hemming spring socket allows cross seam pass
Machine: 1 Needle Lochstitch Machine

标准厚度: M MH H

JINZEN PRODUCT BEAMED MAGNIFICENCE

金振产品 神采飞扬

JZ-15505 A30/121586(F335) 日字埋夹
Side Seam Folder-Japan Style

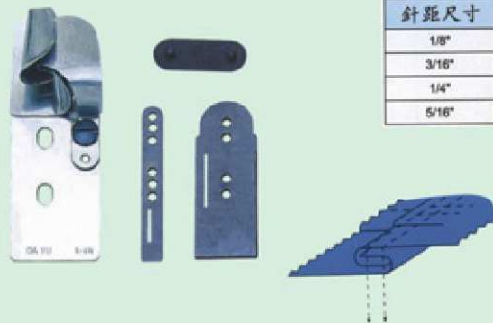

针距尺寸
1/8"
3/16"
1/4"
5/16"

作用: 埋夹
用机: 日本制2、3针埋夹车
Purpose: Sew side seam of thick material
Machine: Japan Made 2、3 Needle Feed of the Arm Machine

标准厚度:	M	MH	H	XH
Standard Thickness:				

JZ-15506 F342 切刀机耳仔筒
Belt Loop Folder for Belt Loop Machine with Cutter

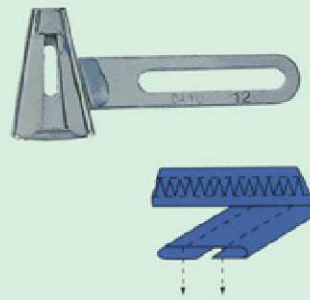

出口
6mm
9mm
10mm
11mm
12mm
13mm
14mm
15mm
16mm
17mm
18mm
20mm

作用: 关西耳仔筒
用机: 双针耳仔车连前切刀
Purpose: Belt loop
Machine: 2 Needle Belt Loop Machine with Front Cutter

标准厚度:	M	MH	H
Standard Thickness:			

JZ-15507 F340 耳仔筒
Belt Loop Folder

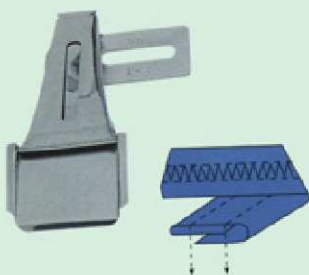

入口	出口
5/8"	1/4"
3/4"	5/16"
7/8"	3/8"
1"	7/16"
1-1/8"	1/2"
1-3/8"	5/8"
1-5/8"	3/4"
1-7/8"	7/8"
2-1/8"	1"

作用: 车耳仔
用机: 双针耳仔车
Purpose: Belt loop
Machine: 2 Needle Belt Loop Machine

标准厚度:	M	MH	H
Standard Thickness:			

JZ-15508 F339 耳仔筒
Belt Loop Folder



入口	出口
1/2"	1/4"
5/8"	5/16"
3/4"	3/8"
7/8"	7/16"
1"	1/2"
1-1/4"	5/8"
1-1/2"	3/4"
1-3/4"	7/8"
2"	1"
2-1/4"	1-1/8"
2-1/2"	1-1/4"

作用: 车耳仔
用机: 双针耳仔车
Purpose: Belt loop
Machine: 2 Needle Belt Loop Machine

标准厚度:	M	MH	H
Standard Thickness:			



JZ-15509 AT112(F524) 双针面贴器
Double Needle Tape Attaching Foot

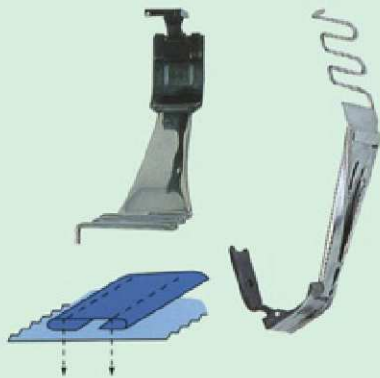

针距尺寸

1/8"
3/16"
1/4"
5/16"
3/8"
1/2"
5/8"
3/4"
7/8"
1"

作用: 车双针面贴
用机: 双针车
Purpose: Attach tape on top of fabric surface
Machine: 2 Needle Machine

标准厚度:
Standard Thickness: M MH H

JZ-15510 K710NA(A)(F402) 脚踏车直角包边筒 (插齿单折可调)
Right Angle Binder
脚踏车直角包边筒 (平齿单折可调)
Right Angle Binder

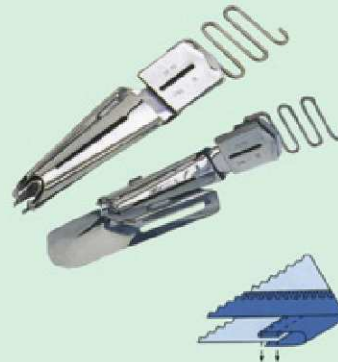

入口	出口
3/8"	1/4"
15/16"	5/16"
1-1/8"	3/8"
1-3/16"	7/16"
1-3/8"	1-1/2"
1-1/2"	9/16"
1-5/8"	5/8"
1-3/4"	11/16"
1-7/8"	3/4"
2-1/8"	7/8"
2-3/8"	1"
2-5/8"	1-1/8"
2-3/4"	1-3/16"
2-7/8"	1-1/4"
3"	1-5/16"
3-1/8"	1-3/8"
3-3/8"	1-1/2"

作用: 拉针线T袖领、袖等
用机: 2或3针拉雷车
Purpose: Binding of knitwear collar and sleeve
Machine: 2 or 3 Needle Cover Stitch Machine

标准厚度:
Standard Thickness: MH H

JZ-15511 K710NA(B)(F401) 脚踏车直角包边筒 (插齿双折可调)
Right Angle Binder
脚踏车直角包边筒 (平齿双折可调)
Right Angle Binder

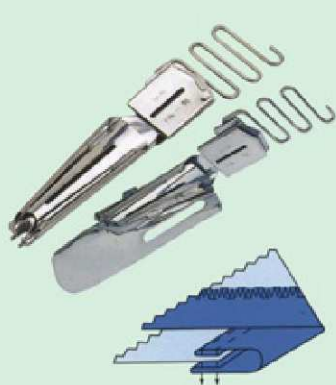

入口	出口
1"	1/4"
1-3/16"	5/16"
1-3/8"	3/8"
1-1/2"	7/16"
1-5/8"	1/2"
1-3/4"	9/16"
1-7/8"	5/8"
2"	11/16"
2-1/8"	3/4"
2-3/8"	7/8"
2-3/4"	1"
3"	1-1/8"
3-1/8"	1-3/16"
3-1/4"	1-1/4"
3-3/8"	1-5/16"
3-1/2"	1-3/8"
3-3/4"	1-1/2"

作用: 拉针线T袖领、袖等
用机: 2或3针拉雷车
Purpose: Binding of knitwear collar and sleeve
Machine: 2 or 3 Needle Cover Stitch Machine

标准厚度:
Standard Thickness: MH H

JZ-15512 A4/100 散口曲嘴包边筒
Edge Binder



入口	出口
3/8"	3/16"
1/2"	1/4"
5/8"	5/16"
3/4"	3/8"
7/8"	7/16"
1"	1/2"
1-1/8"	9/16"
1-1/4"	5/8"
1-3/8"	11/16"
1-1/2"	3/4"

作用: 包缝身布料等
用机: 单针平车
Purpose: Binding of curve edge
Machine: 1 Needle Lockstitch Machine

标准厚度:
Standard Thickness: M MH H

因为用心,所以专业

BECAUSE THE HEART, SO PROFESSIONAL

JZ-15513 A9/508 曲嘴包边筒(环口)
Plain Bias Binder

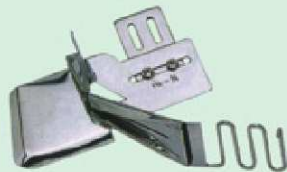

入口	出口
3/4"	3/16"
1"	1/4"
1-1/4"	5/16"
1-1/2"	3/8"
1-3/4"	1/2"
2"	5/8"

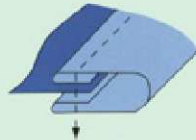

作用: 边
用机: 单针平车
Purpose: Binding edge
Machine: 1 Needle Lockstitch Machine

标准厚度:
Standard Thickness: M MH

JZ-15514 曲嘴包边筒(散口)
Braid or Tape Binder



入口	出口
1/2"	1/4"
5/8"	5/16"
3/4"	3/8"
7/8"	7/16"
1"	1/2"
1-1/8"	9/16"
1-1/4"	5/8"
1-3/8"	11/16"
1-1/2"	3/4"

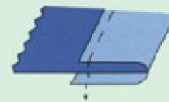

作用: 拉皮革塑胶织带
用机: 单针平车
Purpose: Edge Binder (Leather)
Machine: 1-Needle Lockstitch Machine

标准厚度:
Standard Thickness: M MH H

JZ-15515 飞马包缝车包边筒
Edge Binder for Pegasus Overlock Machine



入口
22mm
24mm
26mm
28mm

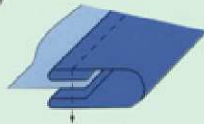

作用: 口袋边包缝
用机: 飞马L22-0E
Purpose: Pocket Binding
Machine: Pegasus L22

标准厚度:
Standard Thickness: M

JZ-15516 祖奇包缝车包边筒(散口)
Edge Binder for JUKI Overlock Machine



入口
1/2"



作用: 布边
用机: 祖奇包缝车

标准厚度:
Standard Thickness: M



JZ-15517

祖奇包缝车包边筒
Edge Binder for Pegasus Overlock Machine

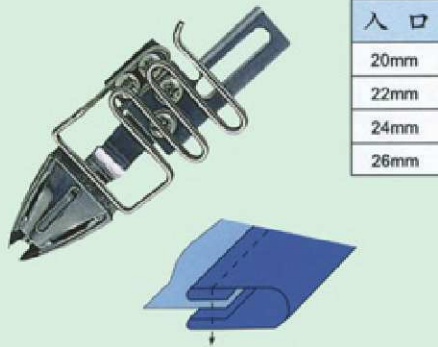

入口
20mm
22mm
24mm
26mm

作用：布边
用机：祖奇包缝车

标准厚度： Standard Thickness:	M
------------------------------	---

JZ-15518

散口鞋边包边筒
Single Needle Binders(for Shoes)

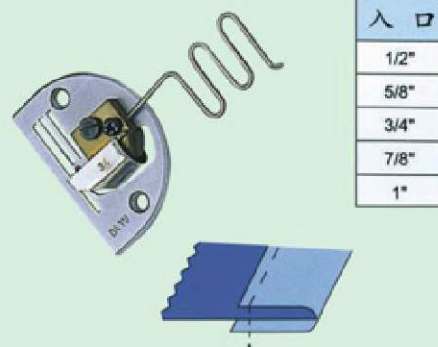

入口
1/2"
5/8"
3/4"
7/8"
1"

作用：厚物、皮革及塑胶材料用
用机：单针平车
Purpose:For Thick Leather and Rubber Material
Machine:1 Needle Lockstitch Machine

标准厚度： Standard Thickness:	H	XH
------------------------------	---	----

JZ-15519

(F515) 平车靴头筒
Loop Folder Foot

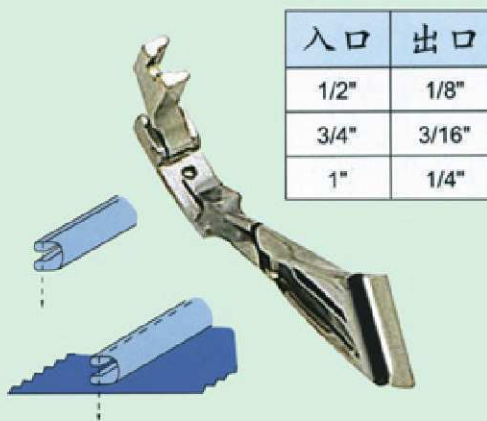

入口	出口
1/2"	1/8"
3/4"	3/16"
1"	1/4"

作用：车耳仔
用机：单针平车
Purpose:Loop sewing
Machine:1 Needle Lockstitch Machine

标准厚度： Standard Thickness:	M	MH
------------------------------	---	----

JZ-15520

(F301) 裤头筒
Waist Band Folder

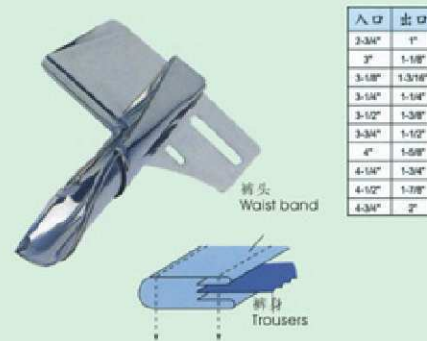

入口	出口
3/32"	1"
3"	1-1/8"
3-1/8"	1-3/16"
3-1/4"	1-1/4"
3-1/2"	1-3/8"
3-3/4"	1-1/2"
4"	1-5/8"
4-1/4"	1-3/4"
4-1/2"	1-7/8"
4-3/4"	2"

作用：缝折裤头、裙头（没有朴）
用机：2或4针裤头车
Purpose:Binding of waist band(without lining)
Machine:2 or 4 Needle Waist Band Machine

标准厚度： Standard Thickness:	MH	H	XH
------------------------------	----	---	----

以客为尊的服务理念!

THE SERVICE IDEA OF GIVING MANY REGARDS TO CUSTOMS

JZ-15521 (F303) 散底裤头筒
Waist Band Folder

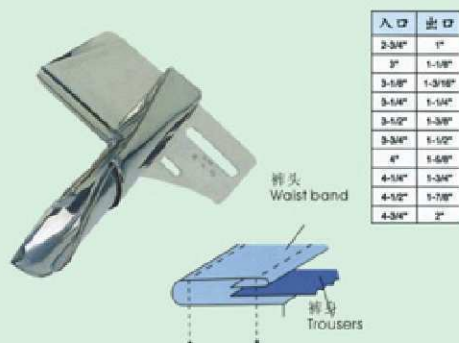

入口	出口
2-3/4"	1"
3"	1-1/8"
3-1/8"	1-3/16"
3-1/4"	1-1/4"
3-1/2"	1-3/8"
3-3/4"	1-1/2"
4"	1-5/8"
4-1/4"	1-3/4"
4-1/2"	1-7/8"
4-3/4"	2"

作用: 缝折裤头、裙头(散底、没有衬)
用机: 2或4针裤头车
Purpose: Binding of waist band (loose bottom, without lining)
Machine: 2 or 4 Needle Waist Band Machine

标准厚度: Standard Thickness:	MH	H	XH
------------------------------	----	---	----

JZ-15522 U12 雨伞筒
Twin Plain Hemmer

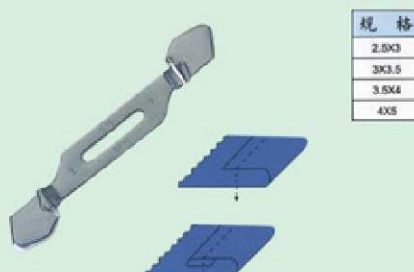

规格
2.5X3
3X3.5
3.5X4
4X5

作用: 拉伞边
用机: 单针平车
Purpose: Umbrella Edge Hemmer
Machine: 1-Needle Lock Stitch Machine

标准厚度: Standard Thickness:	M
------------------------------	---

JZ-15523 A32 双针上袖筒
Double Needle Lap Seam Folder

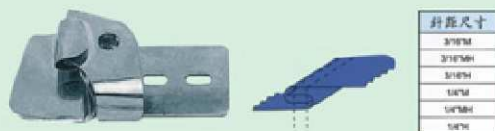

针距尺寸
3/16"
3/16"MH
3/16"H
1/4"
1/4"MH
1/4"H

作用: 缝薄布或恤衫后幅
用机: 双针车
Purpose: Back seam of shirt or light weight fabric
Machine: 2 Needle Machine

JZ-15525 35800(F337) 弹弓嘴迂仁埋夹
Sprig Type Side Seam Folder-Union Special Type

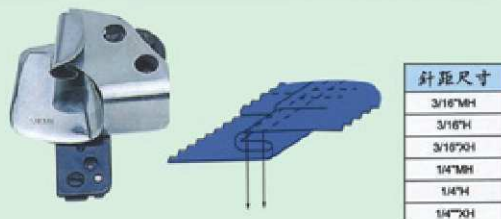

针距尺寸
3/16"MH
3/16"H
3/16"XH
1/4"MH
1/4"H
1/4"XH

作用: 埋夹
用机: 迂仁2、3针埋夹车
Purpose: Sew side seam
Machine: 2,3 Needle Union Special Feed of the Arm Machine

JZ-15524 F514 多条面贴器
Multi Tape Attach Folder

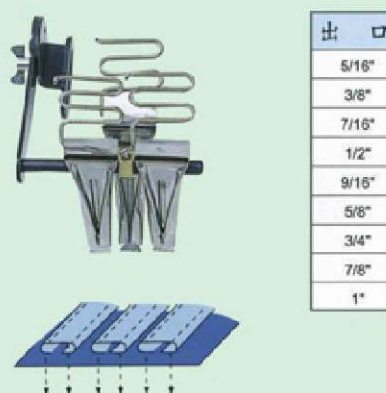

出口
5/16"
3/8"
7/16"
1/2"
9/16"
5/8"
3/4"
7/8"
1"

作用: 机恤装式面贴用
用机: 多针车
Purpose: Decorative tape on jacket
Machine: Multi Needle Machine

标准厚度: Standard Thickness:	M
------------------------------	---



JZ-15526 F404 縫紉車直角包邊筒(插雷子母筒單折可調)
Right Angle Binder with Piping -Loose Bottom

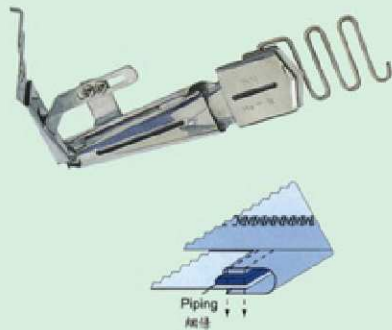

入口	出口
3/4"	1/4"
15/16"	5/16"
1-1/8"	3/8"
1-3/16"	7/16"
1-3/8"	1/2"
1-1/2"	9/16"
1-5/8"	5/8"
1-3/4"	11/16"
1-7/8"	3/4"
2-1/8"	7/8"
2-3/8"	1"

作用: 拉針織T恤領、袖、連網條
用機: 2或3針拉雷車

Purpose: Binding of knitwear collar and sleeve with piping.
Machine: 2 or 3 Needle Cover Stitch Machine

標準厚度: Standard Thickness:	MH	H
------------------------------	----	---

JZ-15527 F400 縫紉車直角包邊筒(插雷子母筒單折可調)
Right Angle Binder with Piping

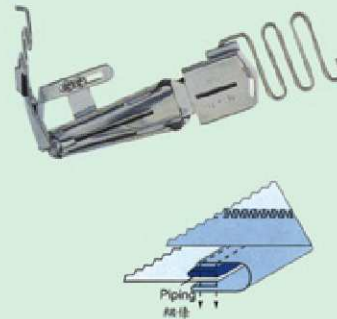

入口	出口
1"	1/4"
1-3/16"	5/16"
1-3/8"	3/8"
1-1/2"	7/16"
1-5/8"	1/2"
1-3/4"	9/16"
1-7/8"	5/8"
2"	11/16"
2-1/8"	3/4"
2-3/8"	7/8"
2-3/4"	1"

作用: 拉針織T恤領、袖、連網條
用機: 2或3針拉雷車

Purpose: Binding of knitwear collar and sleeve with piping.
Machine: 2 or 3 Needle Cover Stitch Machine

標準厚度: Standard Thickness:	MH	H
------------------------------	----	---

JZ-15528 F219 側袖筒
Sleeve Placket Binder

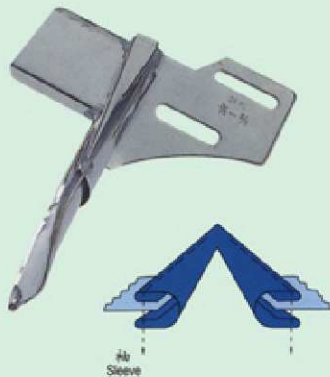

入口	出口
3/4"	3/16"
1"	1/4"
1-1/8"	5/16"
1-1/4"	3/8"
1-3/8"	7/16"
1-5/8"	1/2"
1-7/8"	5/8"
2-1/4"	3/4"
2-1/2"	7/8"
2-3/4"	1"

作用: 縫袖側
用機: 單針平車

Purpose: Attach sleeve placket.
Machine: 1 Needle Lockstitch Machine

標準厚度: Standard Thickness:	M	MH	H
------------------------------	---	----	---

JZ-15529 F302 褲頭筒有補
Waist Band Folder With Lining

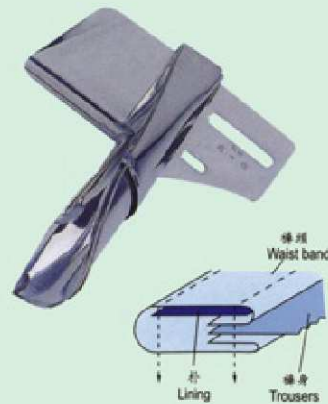

入口	出口
2-3/4"	1"
3"	1-1/8"
3-1/8"	1-3/16"
3-1/4"	1-1/4"
3-1/2"	1-3/8"
3-3/4"	1-1/2"
4"	1-5/8"
4-1/4"	1-3/4"
4-1/2"	1-7/8"
4-3/4"	2"

作用: 縫折褲頭, 裙頭(有橫)
用機: 2或4針褲頭車

Purpose: Hemming waist band with elastic
Machine: 2, 3, 4 Needle Elastic Machine

標準厚度: Standard Thickness:	MH	H	XH
------------------------------	----	---	----

追求卓越, 尽善尽美

The pursuit of excellence, perfection

JZ-15530 F304 散底褲頭筒有補
Waist Band Folder With Lining

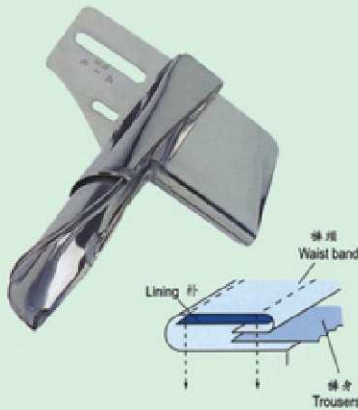

入口	出口
2-3/4"	1"
3"	1-1/8"
3-1/8"	1-3/16"
3-1/4"	1-1/4"
3-1/2"	1-3/8"
3-3/4"	1-1/2"
4"	1-5/8"
4-1/4"	1-3/4"
4-1/2"	1-7/8"
4-3/4"	2"

作用: 縫折褲頭, 裙頭(散底, 有補) Purpose: Binding of waist band (loose bottom, with lining.)
用機: 2或4針褲頭車

Machine: 2 or 4 Needle Waist Band Machine

标准厚度: Standard Thickness:	MH	H	XH
------------------------------	----	---	----

JZ-15531 F305 封咀褲頭筒
Waist Band Folder

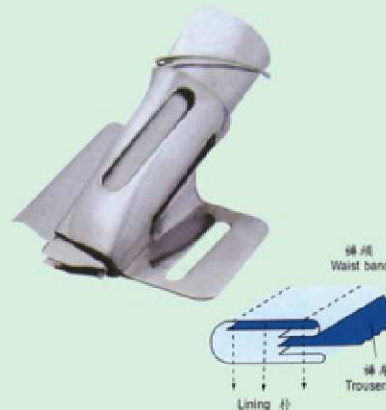

入口	出口
3"	1-1/8"
3-1/8"	1-3/16"
3-1/2"	1-1/4"
3-3/4"	1-3/8"
4"	1-1/2"
4-1/4"	1-5/8"
4-1/2"	1-3/4"
4-3/4"	1-7/8"
5"	2"

作用: 在車縫前, 可先將褲頭內折 Purpose: Close end of waist before stitching
用機: 勝嘉褲頭車 Machine: Singer Waist Band Machine

标准厚度: Standard Thickness:	M	MH
------------------------------	---	----

JZ-15532 F306 封咀褲頭筒(散底)
Waist Band Folder

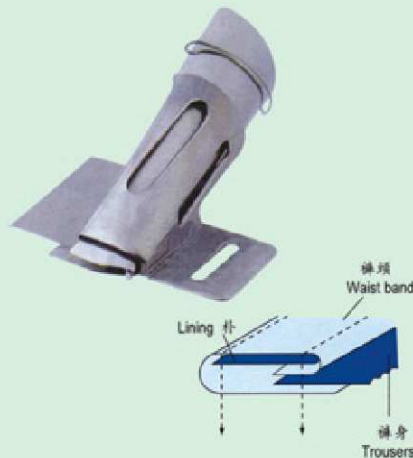

入口	出口
3"	1-1/8"
3-1/8"	1-3/16"
3-1/2"	1-1/4"
3-3/4"	1-3/8"
4"	1-1/2"
4-1/4"	1-5/8"
4-1/2"	1-3/4"
4-3/4"	1-7/8"
5"	2"

作用: 在車縫前, 可先將褲頭內折, (散底, 有補) Purpose: Close end of waist before stitching (loose bottom, with lining.)
用機: 勝嘉褲頭車 Machine: Singer Waist Band Machine

标准厚度: Standard Thickness:	H	XH
------------------------------	---	----

JZ-15533 F218 單針接袖器(單針車用)
Single Needle Sleeve Attachment (Single Needle Operation)

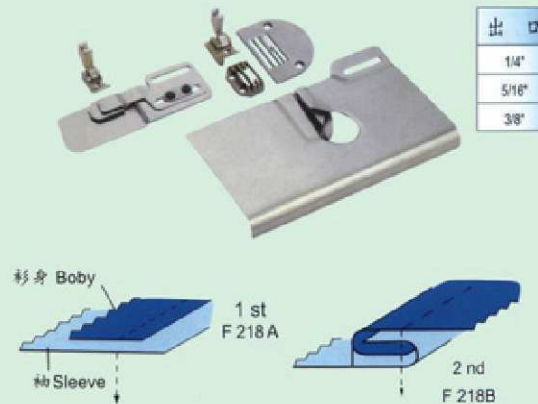

出口
1/4"
5/16"
3/8"

作用: 單針袖 Purpose: Single Needle Sleeve
用機: 單針平車 Machine: 1 Needle Lockstitch Machine

标准厚度: Standard Thickness:	M	MH
------------------------------	---	----



**JZ-15534 432 總子筒(固定式)
Piping Folder**

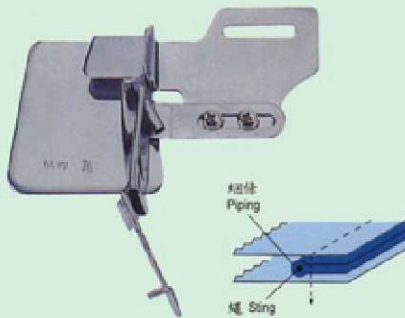

入口	出口
3/8"	3/16"
1/2"	1/4"
5/8"	5/16"
3/4"	3/8"
7/8"	7/16"
1"	1/2"
1-1/8"	9/16"
1-3/16"	19/32"
1-1/4"	5/8"
1-3/8"	11/16"
1-1/2"	3/4"
1-5/8"	13/16"
1-3/4"	7/8"

作用:車綫條連繩仔, 用于睡衣, 枕頭袋等
用機:單針平車

Purpose: Attach piping with sting e. g. pajama and pillow case
Machine: 1 Needle Lockstitch Machine

標準厚度: Standard Thickness:	M	MH	H
------------------------------	---	----	---

**JZ-15535 F521 活動總子筒
Piping Folder**

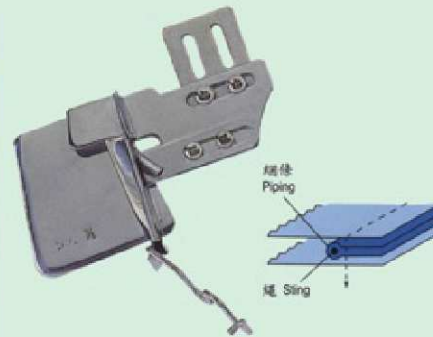

入口	出口
3/8"	3/16"
1/2"	1/4"
5/8"	5/16"
3/4"	3/8"
7/8"	7/16"
1"	1/2"
1-1/8"	9/16"
1-3/16"	19/32"
1-1/4"	5/8"
1-3/8"	11/16"
1-1/2"	3/4"
1-5/8"	13/16"
1-3/4"	7/8"

作用:車綫條連繩仔, 用于睡衣, 枕頭袋等
用機:單針平車

Purpose: Attach piping with sting e. g. pajama and pillow case
Machine: 1 Needle Lockstitch Machine

標準厚度: Standard Thickness:	M	MH	H
------------------------------	---	----	---

**JZ-15536 F201 門襟筒
Top Center Plait Folder**

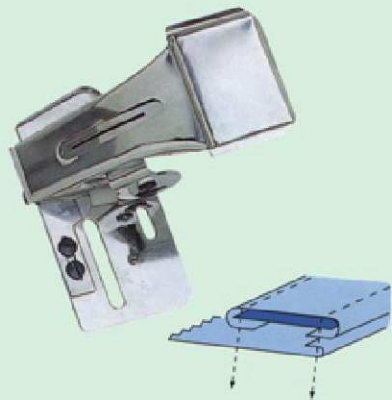

入口	出口
1-1/2"	3/4"
1-3/4"	7/8"
2"	1"
2-1/8"	1-1/8"
2-1/4"	1-1/4"
2-3/8"	1-5/16"
2-3/8"	1-3/8"
2-1/2"	1-1/2"
2-5/8"	1-5/8"
2-3/4"	1-3/4"

作用:男女衫前胸明筒一有衬
用機:2或4針筒車

Purpose: Top centre plait of shirt and blouse—with lining
Machine: 2 or 4 Needle Machine Placket

標準厚度: Standard Thickness:	M	MH
------------------------------	---	----

**JZ-15537 F307 上下布褲頭筒
Two Pieces Waist Band Folder**

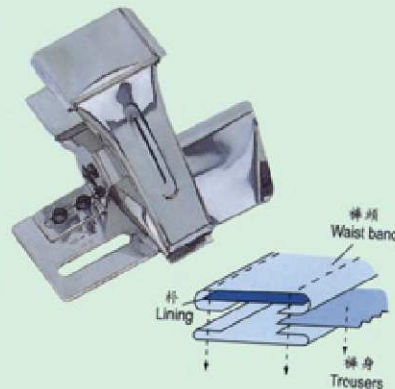

入口	出口
2"	1"
2-1/8"	1-1/8"
2-1/4"	1-1/4"
2-3/8"	1-3/8"
2-1/2"	1-1/2"
2-5/8"	1-5/8"
2-3/4"	1-3/4"
2-7/8"	1-7/8"
3"	2"

作用:縫折褲頭
用機:2或4針褲頭車

Purpose: Attach waist band.
Machine: 2 or 4 Needle Waist Band Machine

標準厚度: Standard Thickness:	MH	M
------------------------------	----	---

灌注東方文化 提煉永久品質 鑄就金振品牌 服務全球客戶

JZ-15538 F308 上下布彎褲頭筒
Two Pieces Curve Waist Band Folder

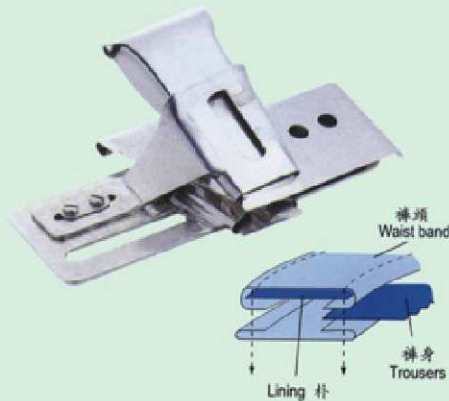

入口	出口
2-1/4"	1-1/4"
2-3/8"	1-3/8"
2-1/2"	1-1/2"
2-5/8"	1-5/8"
2-3/4"	1-3/4"

作用: 縫折彎褲頭
用機: 2或4針褲頭車

Purpose: Attach curve waist band.
Machine: 2 or 4 Needle Waist Band Machine

标准厚度:
Standard Thickness: H XH

JZ-15539 443 縫縫車綫条面點器
Tape Attach Folder for Covering Stitch

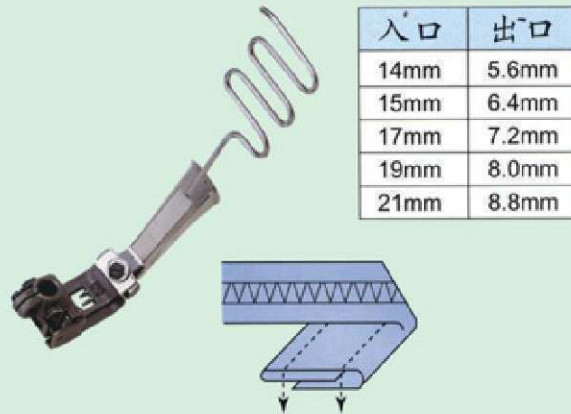

入口	出口
14mm	5.6mm
15mm	6.4mm
17mm	7.2mm
19mm	8.0mm
21mm	8.8mm

JZ-15540 F324 西褲褲頭貼拉筒
Casual Trousers Waist Band Folder

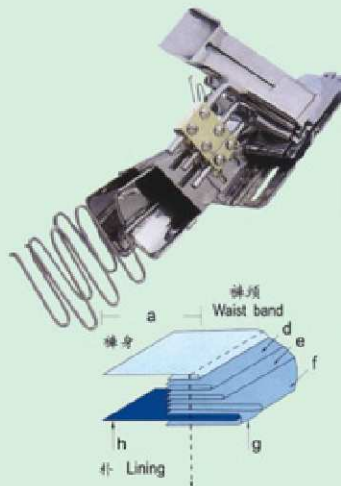

a	1	2	3	4
出口 OUT	1-1/8"	1-1/4"	1-3/8"	1-1/2"
入口 IN	1-1/2"	1-5/8"	1-3/4"	1-7/8"

d	出口 OUT	入口 IN
	3/8"	3/4"

e	出口 OUT	入口 IN
	1/2"	1"

f	1	2	3
出口 OUT	1-1/4"	1-3/8"	1-1/2"
入口 IN	2-1/2"	2-3/4"	3"

g	1	2	3	4
出口 OUT	1-1/8"	1-1/4"	1-3/8"	1-1/2"
入口 IN	2-1/4"	2-1/2"	2-3/4"	3"

h	1-1/4"-2"			
---	-----------	--	--	--

作用: 縫西褲褲頭貼
用機: 褲頭車

Purpose: Sew trousers waist band.
Machine: Waist Band Machine

标准厚度:
Standard Thickness: MH

JZ-15541 F325 西褲褲頭拉筒
Casual Trousers Waist Band Folder

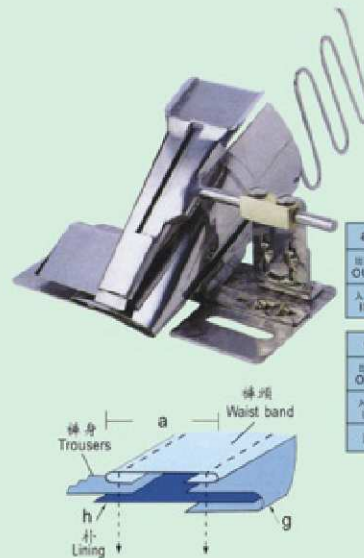

a	1	2	3	4
出口 OUT	3/4"	7/8"	1"	1-1/8"
入口 IN	1-1/2"	1-5/8"	1-3/4"	2"

g	1	2	3	4
出口 OUT	1-1/8"	1-1/4"	1-3/8"	1-1/2"
入口 IN	2-1/4"	2-1/2"	2-3/4"	3"

h	1-1/4"-2"			
---	-----------	--	--	--

作用: 縫西褲褲頭
用機: 褲頭車

Purpose: Sew trousers waist band.
Machine: Waist Band Machine

标准厚度:
Standard Thickness: MH



JZ-15542 KS138(A-31) 衣袖接縫器
Lap Seam Folder



作用:薄布埋夾用
用機:日本制2、3針埋夾車
Purpose: Sew side seam of light
light weight fabric
Machine: Japan Made 2、3 Needle
Feed of the Arm Machine

标准厚度: Standard Thickness:	M	MH	H	XH	Needle Space 針距	3/16	1/4
------------------------------	---	----	---	----	--------------------	------	-----

JZ-15543 KS177 帽子助縫器
Hat & Cap Attachment

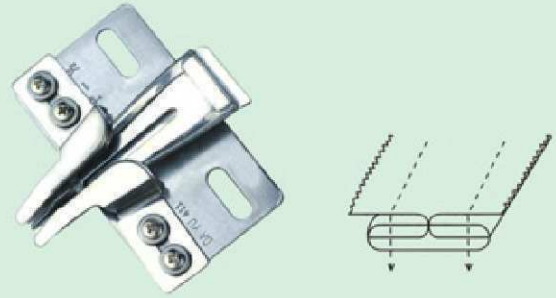

作用:車帽開骨
用機:2、4針車用
Purpose: Hat Folder
Machine: 2、4 Needle Machine

尺寸 size	入口 Bias Tape Sizes	1"	1-1/8"
------------	-----------------------	----	--------

JZ-15544 F535 暗機耳仔筒
Spaghetti Attachment

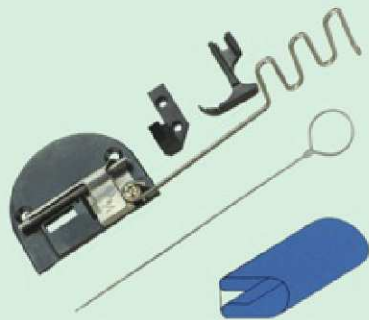

入口	出口
1/2"	1/8"
3/4"	3/16"
1"	1/4"
1-1/4"	5/16"
1-3/8"	3/8"
1-3/4"	1/2"

作用:車暗機耳仔筒
用機:車針平車
Purpose: Make spaghetti like tube.
Machine: 1 Needle Lockstitch Machine

标准厚度: Standard Thickness:	M
------------------------------	---

JZ-15545 F538 三尖側貼筒
Triangular Sleeve Placket Folder



作用:折三尖側貼
用機:熱壓縫機
Purpose: Fold triangular sleeve placket
Machine: Hot Roll Machine

标准厚度: Standard Thickness:	MH	H	XH
------------------------------	----	---	----

OUR QUALITY, YOUR TRUST

JZ-15546 KS232 平車打條器
Pin Tuck Attachment

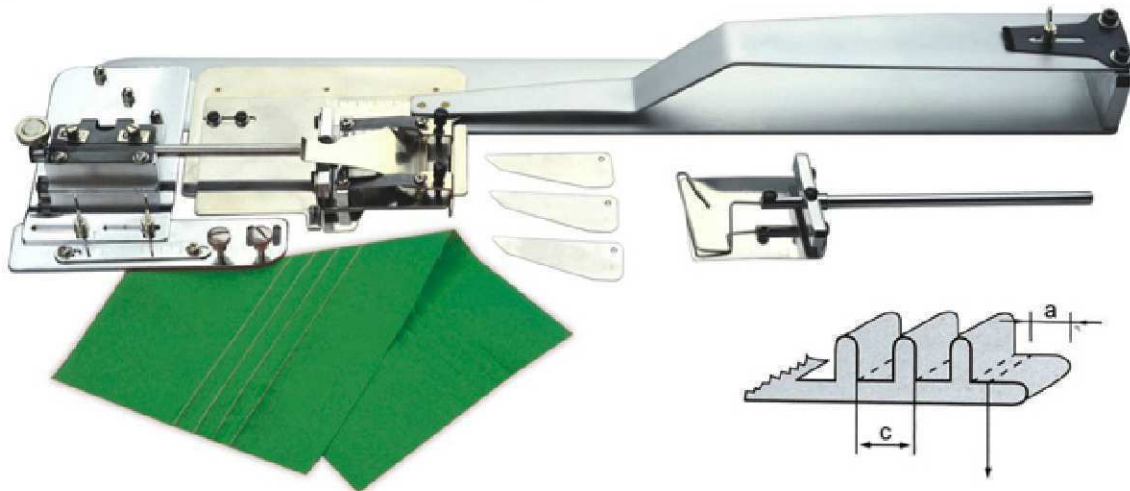

作用:暗綫打條
用機:單針平車
Purpose: Loop sewing
Machine: 1 Needle Lockstitch Machine

MF 533			Standard	
SIZE (inch)	a	1/16 - 1	Thickness:	
	c	1/8 - 11/2	T	MT

JZ-15547 PTV多針打褶器

6針 3/8 (9.5mm) 1/2 (12.7mm)
12針 3/16 (4.8mm) 1/4 (6.4mm)
16針 3/16 (4.8mm)
21針 1/8 (3.2mm)
25針 3/16 (4.8mm) 1/4 (6.4mm) 3/16 (4.8mm)

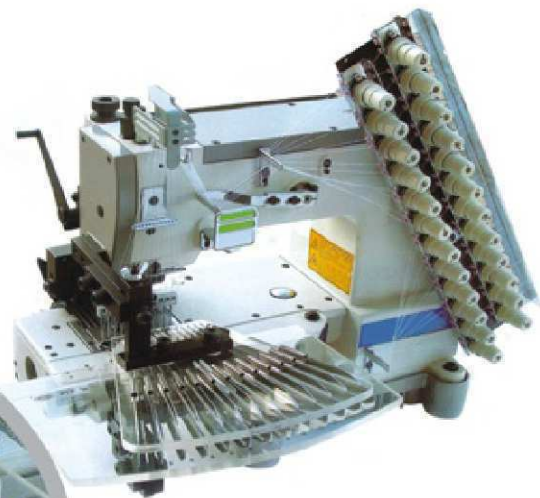
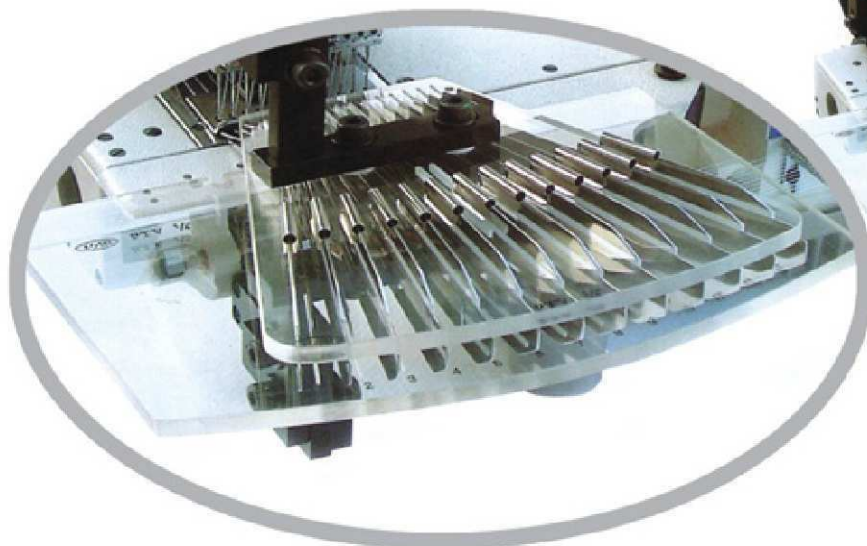



JZ-15548

E102

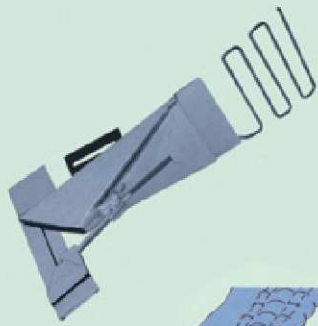

CUT mm	FINISH mm
100	50
110	55
120	60
130	65

RUBBER mm
30
35
40
50

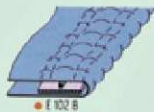
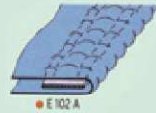

JZ-15549

E126



CUT mm	FINISH mm
40	20
45	22
50	25
55	27
60	30
65	32
70	35
75	37
80	40
85	42
90	45
95	47
100	50
105	52
110	55

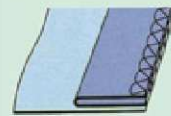

JZ-15550

C218



RUBBER mm
20
35
50
60
70
80
100

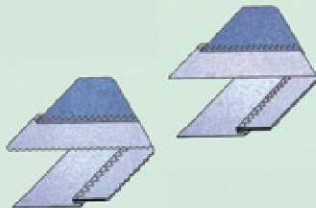

JZ-15551

P007



CUT mm	FINISH mm
55	18
60	20
70	25
85	30
95	35
100	40
110	42
120	45
125	50



因为用心,所以专业

BECAUSE THE HEART, SO PROFESSIONAL

JZ-15552 P010



CUT mm	FINISH mm
55	20
70	25
80	30
90	35
95	40
100	42
105	45

JZ-15553 P020

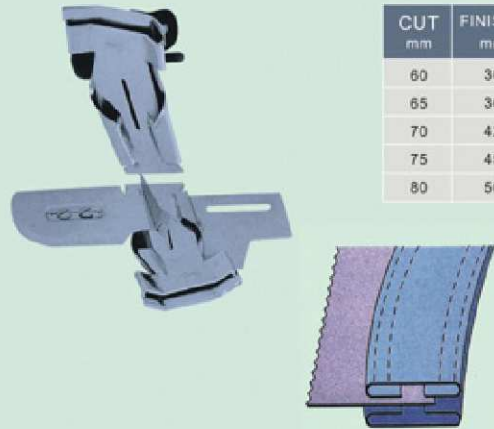

CUT mm	FINISH mm
60	30
65	36
70	42
75	45
80	50

JZ-15554 P024



FINISH mm
12
16

JZ-15555 P031

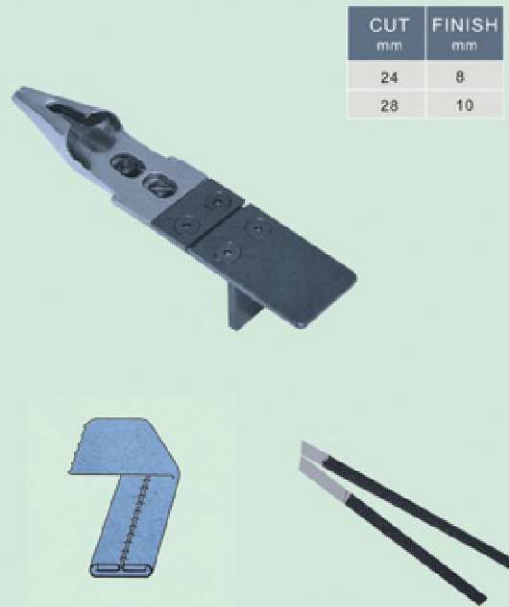

CUT mm	FINISH mm
24	8
28	10



JZ-15556 P032

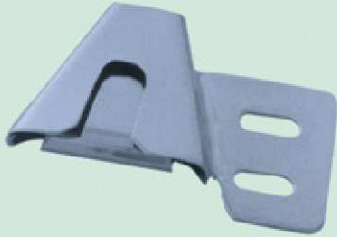

CUT mm	FINISH mm
25	10
28	12
30	13
35	15
38	17
45	20

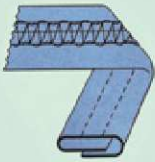

JZ-15557 P040



THICK MATERIAL mm	FINISH mm
H	10
XH	10
XH	12

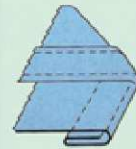

JZ-15558 P044C

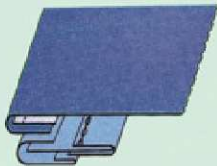
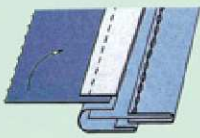
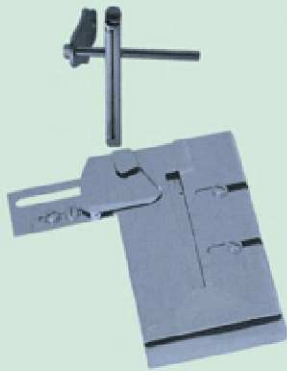

JZ-15559 B815



JZ-15560 B813



以客为尊的服务理念!
THE SERVICE IDEA OF GIVING MANY REGARDS TO CUSTOMS

JZ-15561 B810

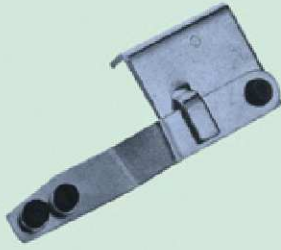

JZ-15562 B811



JZ-15563 B816

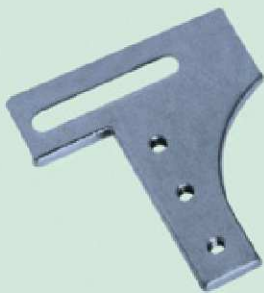

JZ-15564 B812



JZ-15565 B817



JZ-15566 B818

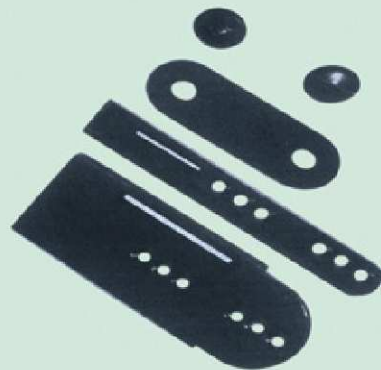

JINZEN®



JZ-15651



JZ-15652



JZ-15653



JZ-15654



JZ-15655



JZ-15656



JZ-15657



JZ-15658



JZ-15659



JZ-15660



JZ-15661



JZ-15662



JZ-15663



JZ-15664



JZ-15665



JZ-15666



JZ-15667



JZ-15668



JZ-15669



JZ-15670



JZ-15671



JZ-15672



JZ-15673



JZ-15674



JZ-15675

FEED PLATE



JZ-15676



JZ-15677



JZ-15678



JZ-15679



JZ-15680



JZ-15681



JZ-15682



JZ-15683



JZ-15684



JZ-15685



JZ-15686



JZ-15687



JZ-15688



JZ-15689



JZ-15690



JZ-15691



JZ-15692



JZ-15693



JZ-15694



JZ-15695



JZ-15696



JZ-15697



JZ-15698



JZ-15699



JZ-15700

JINZEN® WORK CLAMP



JZ-15801



JZ-15802



JZ-15803



JZ-15804



JZ-15805



JZ-15806



JZ-15807



JZ-15808



JZ-15809



JZ-15810



JZ-15811



JZ-15812



JZ-15813



JZ-15814



JZ-15815



JZ-15816



JZ-15817



JZ-15818



JZ-15819



JZ-15820



JZ-15821



JZ-15822



JZ-15823



JZ-15824



JZ-15825

以客为尊的服务理念!

THE SERVICE IDEA OF GIVING MANY REGARDS TO CUSTOMS



JZ-15826



JZ-15827



JZ-15828

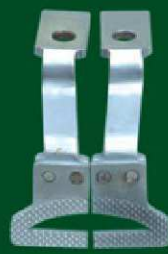

JZ-15829

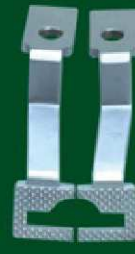

JZ-15830

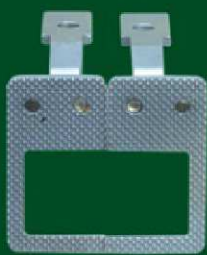

JZ-15831



JZ-15832



JZ-15833

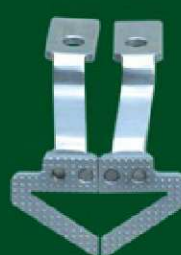

JZ-15834



JZ-15835



JZ-15836

JZ-15839

JZ-15840

JZ-15841

JZ-15842

JZ-15838

JZ-15837

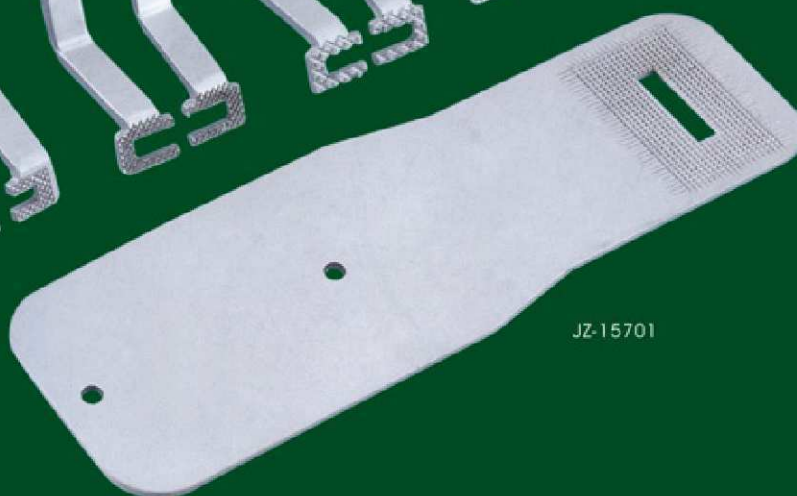

JZ-15701



JZ-15843



JZ-15844

JUKI



JZ-16101

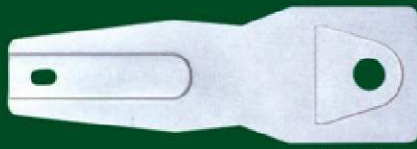

JZ-16103



JZ-16105

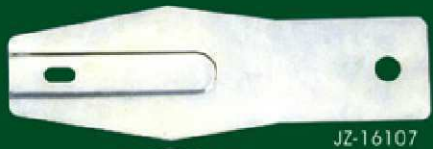

JZ-16107



JZ-16109

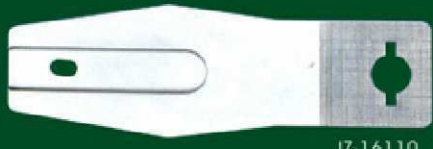

JZ-16110



JZ-16112

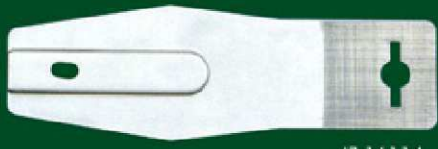

JZ-16114



JZ-16116



JZ-16102

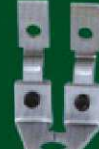

JZ-16104



JZ-16106



JZ-16108



JZ-16111



JZ-16113



JZ-16115



JZ-16117

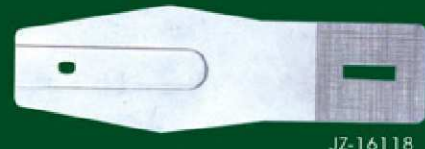

JZ-16118

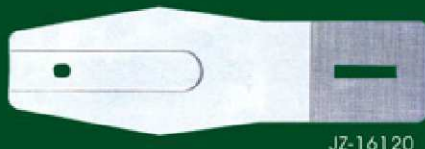

JZ-16120

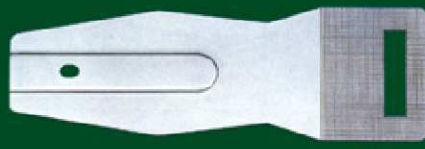

JZ-16122

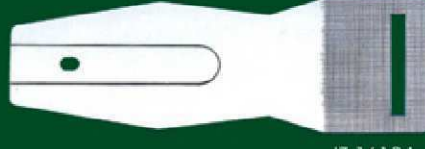

JZ-16124



JZ-16126



JZ-16128



JZ-16130

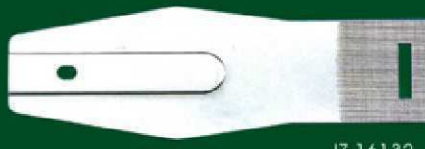

JZ-16132



JZ-16134



JZ-16119



JZ-16121



JZ-16123



JZ-16125



JZ-16127



JZ-16129



JZ-16131



JZ-16133



JZ-16135



JZ-16136



JZ-16137

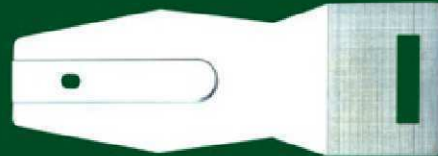

JZ-16138

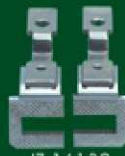

JZ-16139



JZ-16140

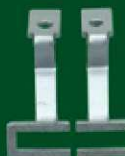

JZ-16141

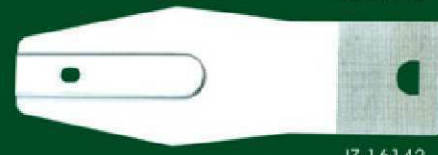

JZ-16142



JZ-16143



JZ-16144



JZ-16145

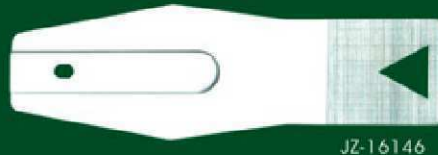

JZ-16146



JZ-16147



JZ-16148



JZ-16149

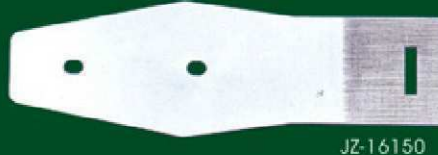

JZ-16150



JZ-16151



JZ-16152

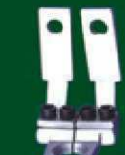

JZ-16153

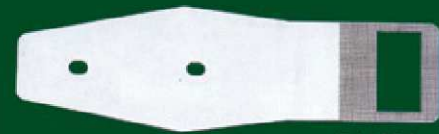

JZ-16154



JZ-16155



JZ-16156



JZ-16157

brother



JZ-16158



JZ-16159



JZ-16160



JZ-16161



JZ-16162



JZ-16163



JZ-16164



JZ-16165



JZ-16166



JZ-16167



JZ-16168



JZ-16169

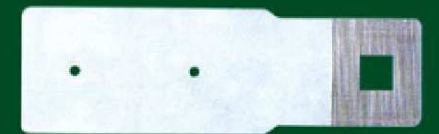

JZ-16170



JZ-16171

2014 JINZHEN IMPORT & EXPORT CO.,LTD.

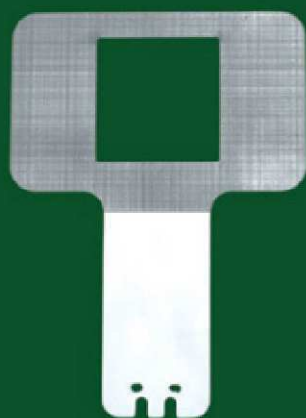

JZ-16351



JZ-16352



JZ-16353

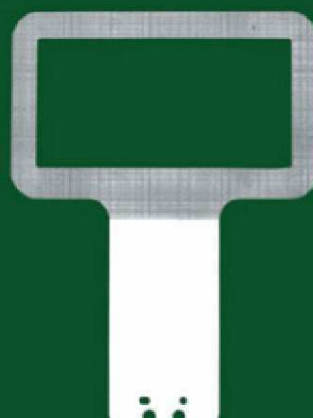

JZ-16354



JZ-16355



JZ-16356



JZ-16357



JZ-16358

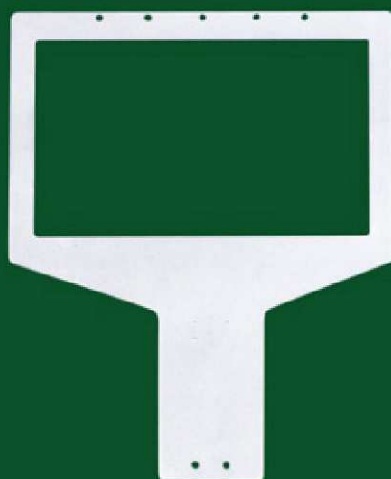

JZ-16359



JZ-16360

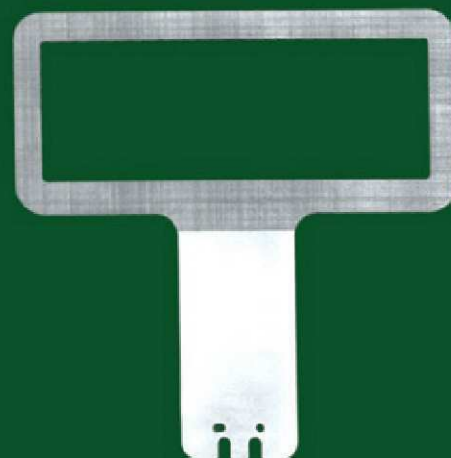

JZ-16361

JZ-16501 JUKI 5550 FOOT BAR

JZ-16502 铝合金针杆

JZ-16503 BROTHER 101

JZ-16504 5550 小孔针杆

JZ-16505 5550 大孔针杆

JZ-16506 JUKI 761

JZ-16507 JUKI 781

JZ-16508 JUKI 373

JZ-16509 JUKI 271

JZ-16510 SINGER 20U

JZ-16511 PEGASUS M600

JZ-16512 PEGASUS M700

JZ-16513 BROTHER 551

JZ-16514 BROTHER N31

JZ-16515 JUKI MO 3316

JZ-16516 GD8-1

JZ-16517 JUKI 515

JZ-16518 1162 FOOT BAR

JZ-16519 BROTHER 845

JZ-16520 JUKI 3168 FOOT BAR

JZ-16521 PF 335

JZ-16522 810

JZ-16523 820

JZ-16524 9910

JZ-16525 9920

JZ-16526 BROTHER 430

JZ-16527 JUKI 1850

JZ-16528 BROTHER 814

JZ-16529 311 平锁

JZ-16530 KASAI 1404

JZ-16531 YAMATO 2500

JZ-16532 PEGASUS W500

JZ-16533 PEGASUS W600

JZ-16534 SIRUBA F007

JZ-16535 SIRUBA C007

JZ-16536 EMBROIDERY

JZ-16537 JUKI 522

JZ-16538 GC 6-7

JZ-16539 JUKI 3168

JZ-16540 无油平车针杆 FREE OIL